

**FLEX MOULDING, INC.**

**MOULDING PROFILE  
CATALOGUE**

**16 EAST LAFAYETTE STREET**

**HACKENSACK, NJ 07601**

**(201) 487-8080 • 1 (800) 307-3357 • FAX: (201) 487-6637**

**WEBSITE: [www.flexiblemoulding.com](http://www.flexiblemoulding.com)**

# FLEX MOULDING, INC.

## Flexible Moulding & Spot Decorations

### PROFILE CATALOG (INTRO)

---

Our unique polyester mouldings offer all advantages of wood but with an added feature of flexibility. Flex Moulding can be manufactured in several grades from very flexible to fully rigid depending on use. Flex Moulding can also be made in Fire Retardant (FR) or Fireproof (FP) material.

This catalog shows complete profiles of all stock mouldings. New mouldings are constantly being added to the line. Any of these mouldings can be cast into radius or free curve to your order.

Flex Moulding can also be supplied as preformed arches to your specifications.

We can reproduce any item you may wish to have copied.

In addition to our profile catalog, we have a full 60 page catalog offering Spot Decorations, Columns, Plaques, Ornamental Carvings, Rosettes, Mirror Frames, Table Legs and our complete line of mouldings. For retail locations we can supply promotional aids and samples.

If you would like our full catalog or have any questions please call us at 1-800-307-3357. Our experienced staff would be happy to assist you with any project or design application.

# FLEX MOULDING, INC.

## TABLE OF CONTENTS

ASTRAGAL .....	2
BACKBAND.....	2
BASE.....	3,4,5,7,8,9
BASE CAP .....	10
BEADS .....	11
BED.....	11
BOLECTION .....	11,12
BRICK.....	12
BULLNOSE .....	12
CASING .....	13,14,15,16,17,18,19,20
CHAIR RAIL .....	20,21,22
CHAMFER STRIP.....	22
CORNER GUARDS .....	22
COVE.....	23
CROWN .....	24,25,26,27,28,29,30,31,32,33,34
CROWN (SOLID).....	35,36,37
GLASS BEAD .....	37
HALF ROUND.....	37,38
HAND RAIL .....	38
MISCELLANEOUS .....	38,39
MULLION .....	39
NOSE & COVE .....	39
PANEL .....	40,41,42
PICTURE .....	43
PILASTER.....	43
QUARTER ROUND.....	44
SHELF EDGE.....	43
RECTANGULAR / SQUARE STOCK.....	44,45
SHOE.....	45
STOOL .....	45
STOP .....	45

PUBLISHED BY FLEX MOULDING, INC. COPYRIGHT 1999

**FLEX MOULDING, INC.**

16 EAST LAFAYETTE STREET

HACKENSACK, NJ 07601

(201) 487-8080 • 1 (800) 307-3357 • FAX: (201) 487-6637

WEBSITE: [www.flexiblemoulding.com](http://www.flexiblemoulding.com)

# ASTRAGAL



7/8" W x 3/8" DP



1 1/8" W x 7/16" DP

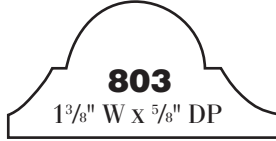

1 3/8" W x 5/8" DP

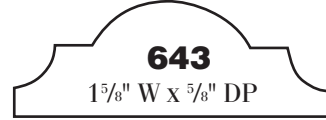

1 5/8" W x 5/8" DP

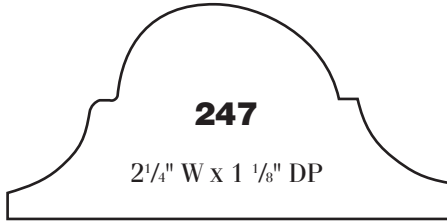

2 1/4" W x 1 1/8" DP

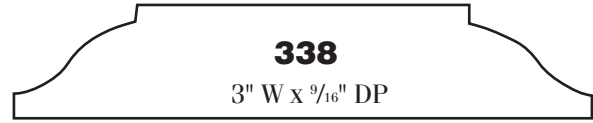

3" W x 9/16" DP

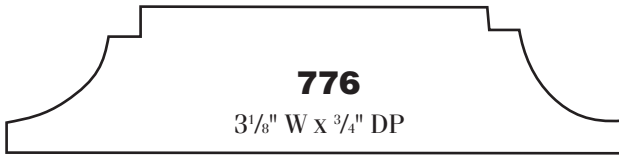

3 1/8" W x 3/4" DP

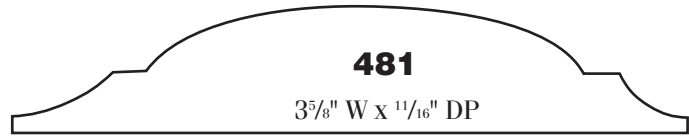

3 5/8" W x 11/16" DP

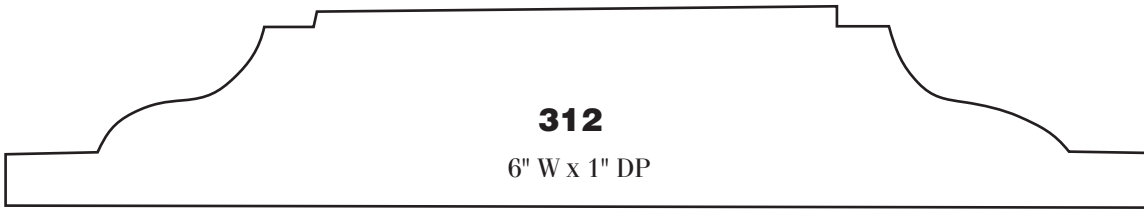

6" W x 1" DP

# BACK BAND

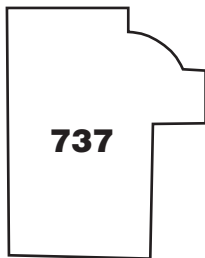

1" W x 1 1/4" DP

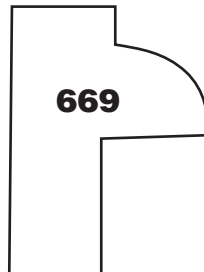

1 5/16" W x 1 5/16" DP

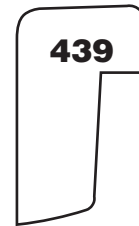

1 1/8" W x 1 1/16" DP

# FLEX MOULDING, INC.

## BASE

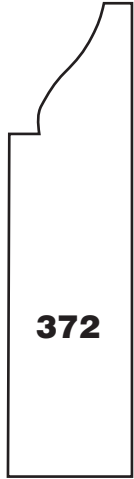

**372**

2<sup>7</sup>/<sub>16</sub>" W x 5<sup>5</sup>/<sub>8</sub>" DP

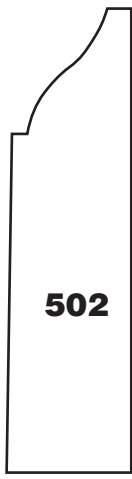

**502**

2<sup>1</sup>/<sub>2</sub>" W x 1<sup>11</sup>/<sub>16</sub>" DP



**429**

3" W x 1<sup>1</sup>/<sub>2</sub>" DP x  
9' L\*

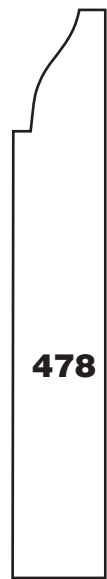

**478**

3" W x 1<sup>1</sup>/<sub>2</sub>" DP



**368**

3<sup>3</sup>/<sub>16</sub>" W x 1<sup>1</sup>/<sub>2</sub>" DP



**261**

3<sup>1</sup>/<sub>4</sub>" W x 1<sup>1</sup>/<sub>2</sub>" DP

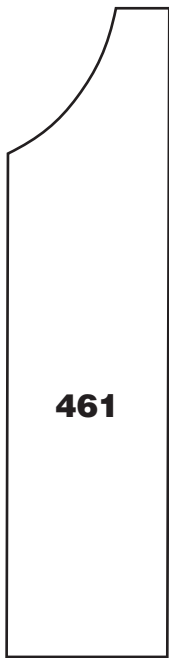

**461**

3<sup>3</sup>/<sub>8</sub>" W x 7<sup>7</sup>/<sub>8</sub>" DP



**450**

3<sup>1</sup>/<sub>2</sub>" W x 1<sup>11</sup>/<sub>16</sub>" DP



**517**

3<sup>1</sup>/<sub>2</sub>" W x 1<sup>11</sup>/<sub>16</sub>" DP

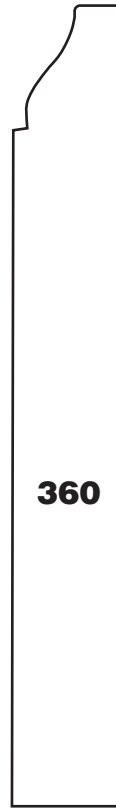

**360**

4<sup>1</sup>/<sub>4</sub>" W x 1<sup>1</sup>/<sub>2</sub>" DP

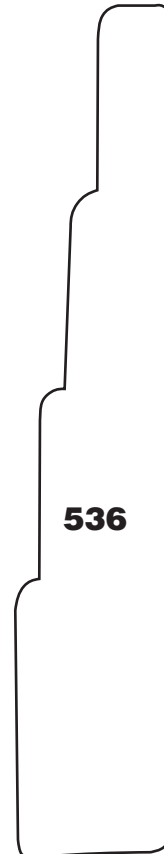

**536**

4<sup>3</sup>/<sub>8</sub>" W x 3<sup>3</sup>/<sub>4</sub>" DP  
x 6' L\*



**472**

4<sup>3</sup>/<sub>8</sub>" W x 3<sup>3</sup>/<sub>4</sub>" DP

\*STANDARD IS 8' LENGTHS, EXCEPT WHERE NOTED

## BASE

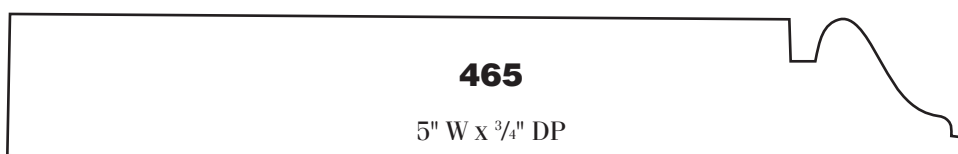
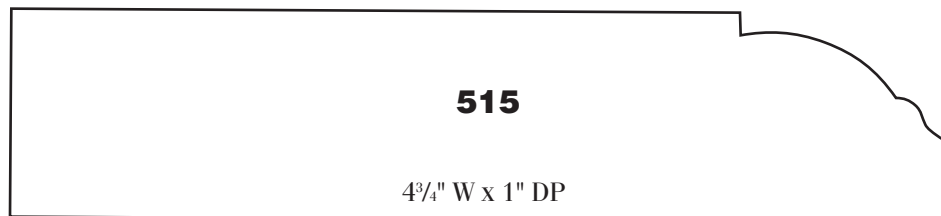
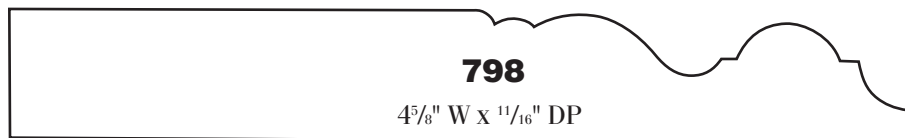
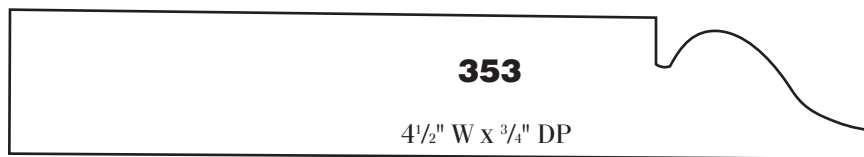
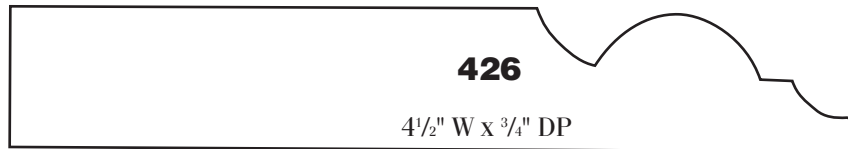
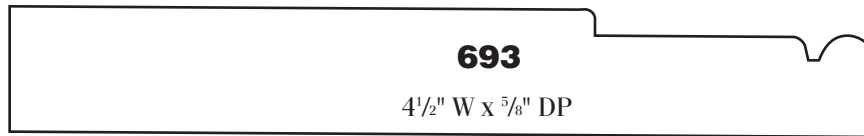
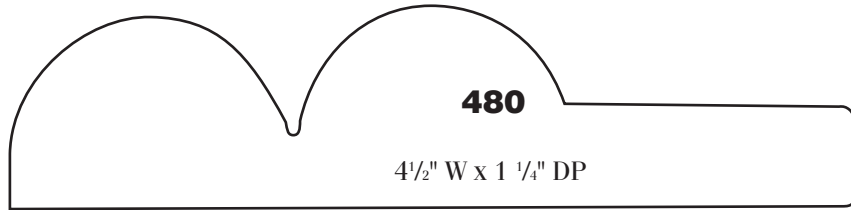

## BASE

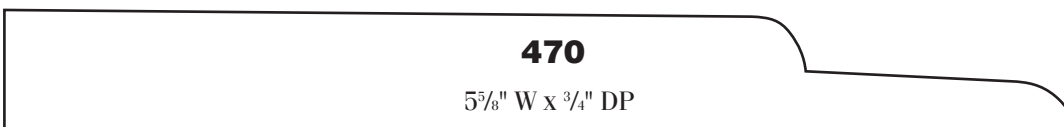
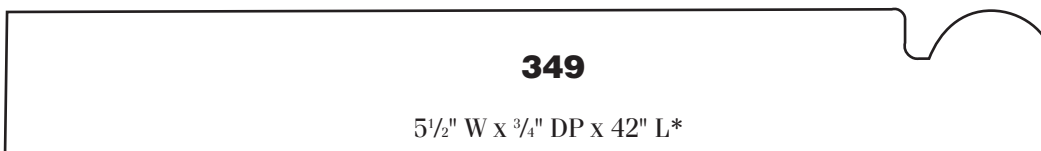
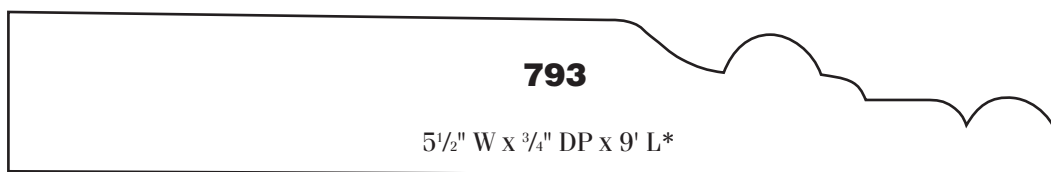
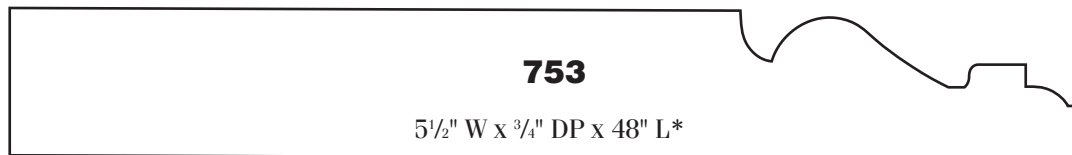
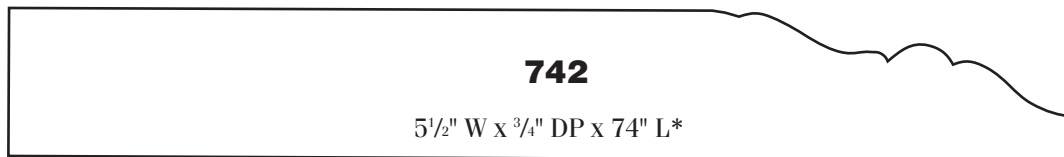
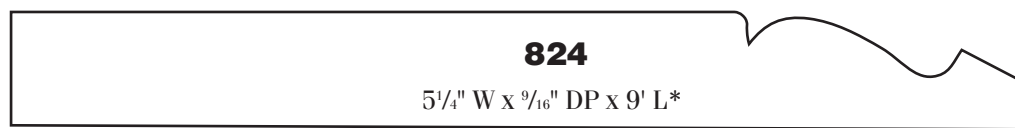
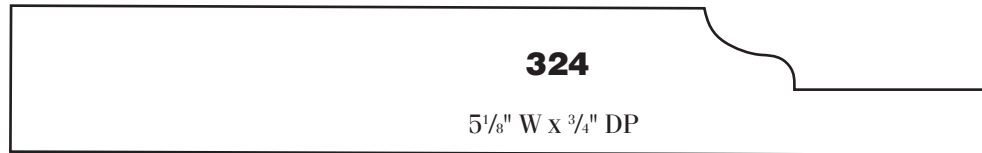
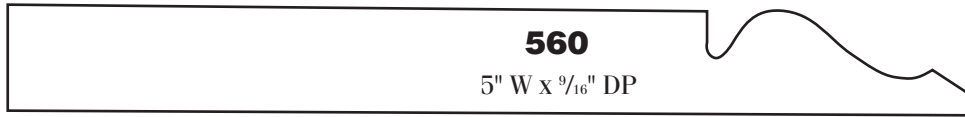

## BASE

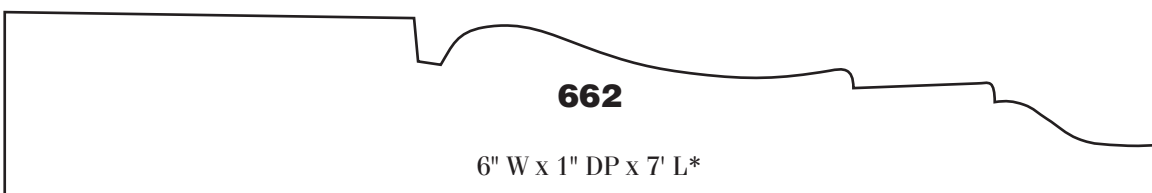
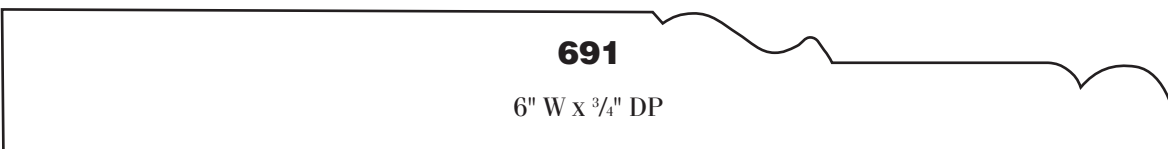
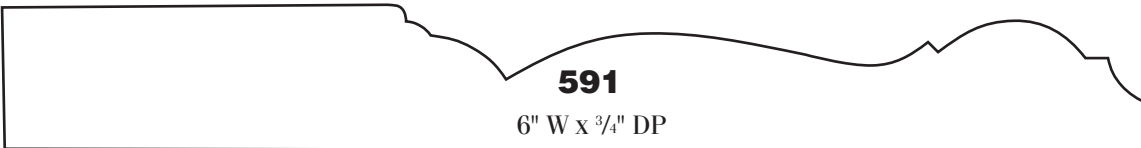
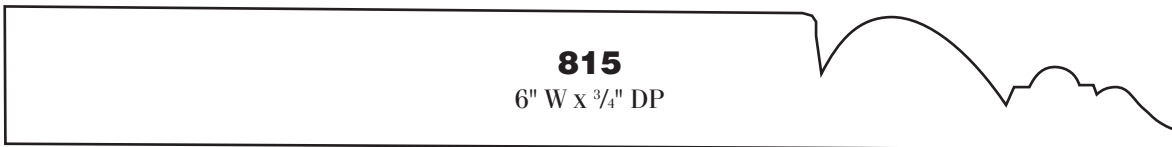
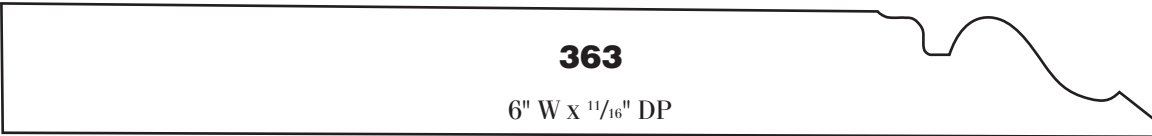
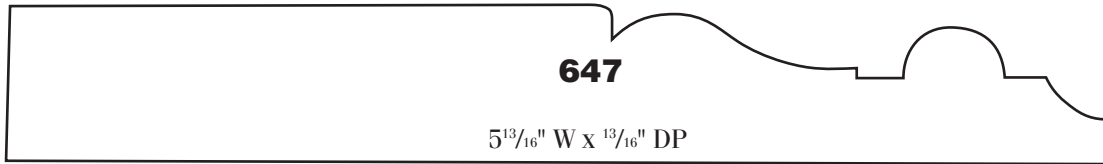
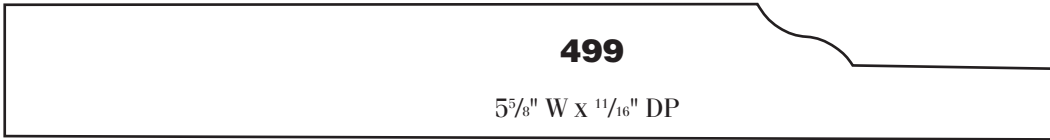



## BASE

**281**

6" W x 1" DP x 60" L\*



**357**

6" W x 1" DP



**411**

6" W x 1 7/8" DP x 79" L\*



**513**

6 5/8" W x 3/4" DP



**573**

6 3/8" W x 3/4" DP



**705**

6 3/4" W x 7/8" DP



# FLEX MOULDING, INC.

## BASE

**458**

6<sup>7</sup>/<sub>8</sub>" W x 1" DP



**762**

7" W x 1<sup>3</sup>/<sub>16</sub>" DP

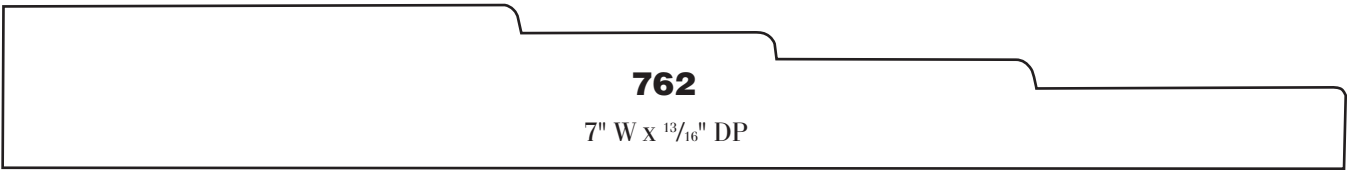

**744**

7" W x 3/4" DP

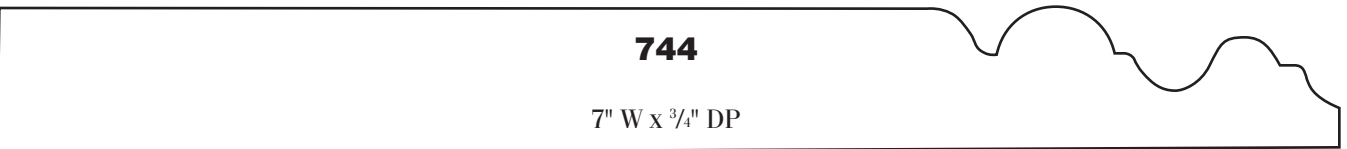

**861**

7" W x 7/8" DP

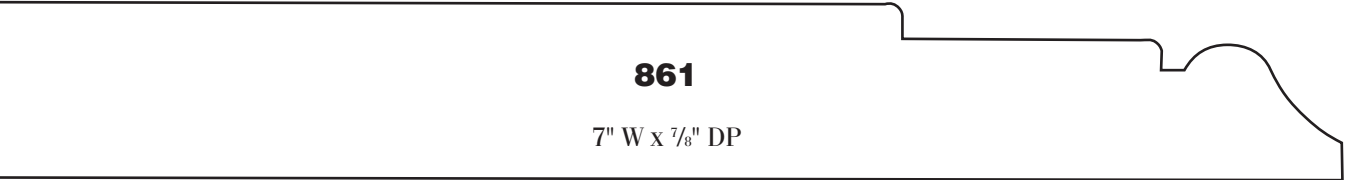

**725**

7" W x 1" DP



**853**

7<sup>1</sup>/<sub>8</sub>" W x 3/4" DP



**425**

7<sup>1</sup>/<sub>8</sub>" W x 3/4" DP



**822**

7<sup>1</sup>/<sub>4</sub>" W x 1<sup>3</sup>/<sub>16</sub>" DP

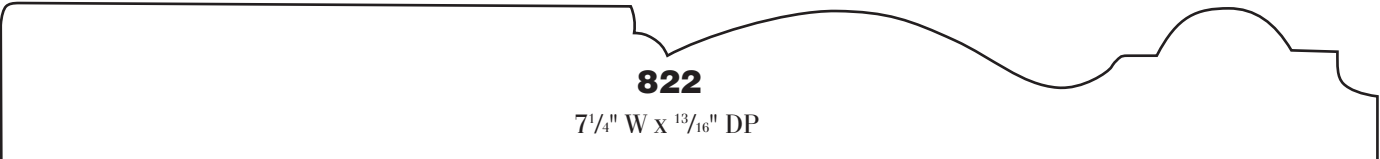

# FLEX MOULDING, INC.

## BASE

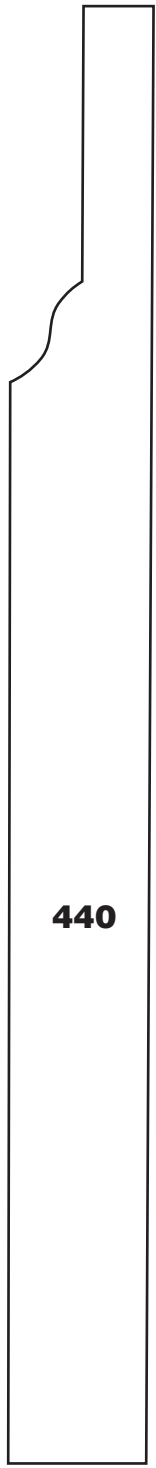

**440**

7<sup>5</sup>/<sub>8</sub>" W x 1<sup>1</sup>/<sub>16</sub>" DP

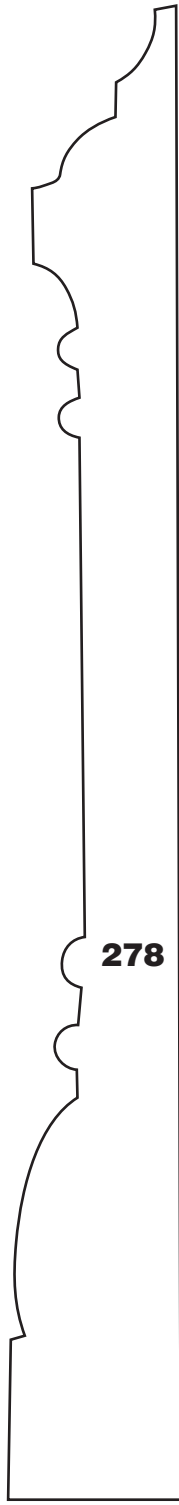

**278**

7<sup>13</sup>/<sub>16</sub>" W x 7<sup>7</sup>/<sub>8</sub>" DP  
x 6' L\*



**789**

8" W x 3<sup>3</sup>/<sub>4</sub>" DP

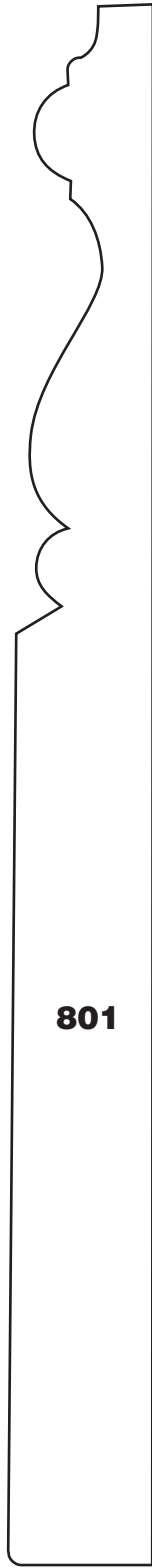

**801**

8<sup>5</sup>/<sub>8</sub>" W x 3<sup>3</sup>/<sub>4</sub>" DP

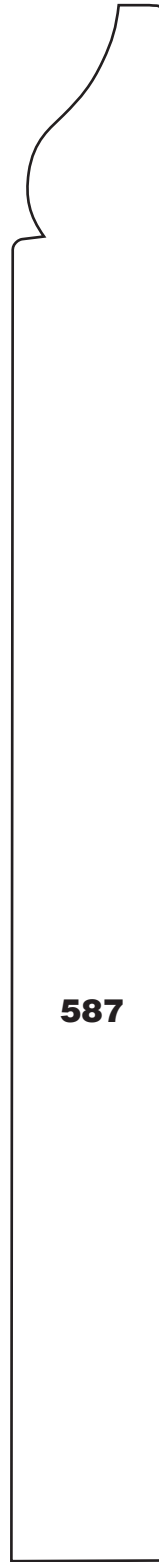

**587**

8<sup>1</sup>/<sub>8</sub>" W x 3<sup>3</sup>/<sub>4</sub>" DP



**851**

8<sup>5</sup>/<sub>8</sub>" W x 3<sup>3</sup>/<sub>4</sub>" DP  
x 10' L\*

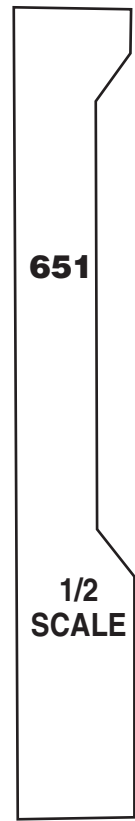

**651**

1/2  
SCALE

9<sup>1</sup>/<sub>2</sub>" W x 1<sup>1</sup>/<sub>4</sub>" DP

\*STANDARD IS 8' LENGTHS, EXCEPT WHERE NOTED

# FLEX MOULDING, INC.

## BASE CAP

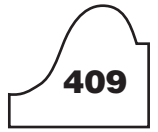

**409**  
3/4" W X 5/8" DP



**274**  
1 3/8" W X 5/8" DP X 80" L\*

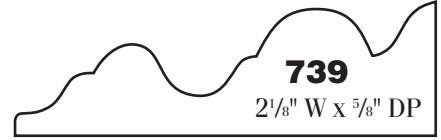

**739**  
2 1/8" W X 5/8" DP

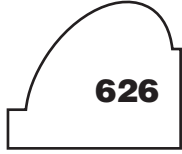

**626**  
7/8" W X 3/4" DP X 5' L\*



**623**  
1 3/8" W X 5/8" DP X 44" L\*

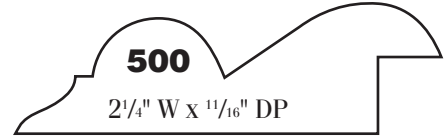

**500**  
2 1/4" W X 11/16" DP

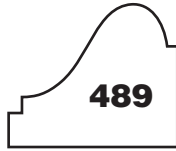

**489**  
7/8" W X 3/4" DP



**455**  
1 3/8" W X 11/16" DP

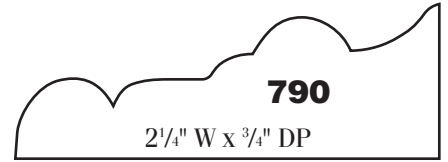

**790**  
2 1/4" W X 3/4" DP



**576**  
1 1/16" W X 5/8" DP

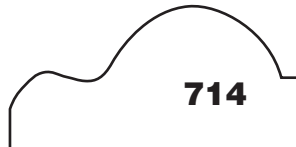

**714**  
1 1/2" W X 5/8" DP

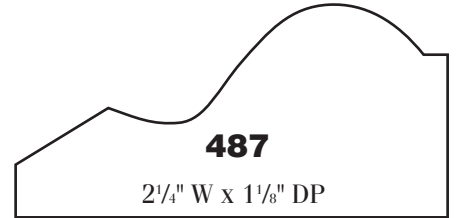

**487**  
2 1/4" W X 1 1/8" DP

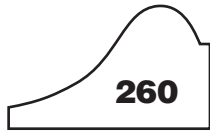

**260**  
1 1/8" W X 1/2" DP



**424**  
1 1/2" W X 5/8" DP

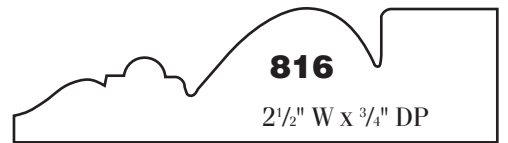

**816**  
2 1/2" W X 3/4" DP



**328**  
1 1/8" W X 11/16" DP



**449**  
1 5/8" W X 11/16" DP X 10' L\*



**721**

3 5/8" W X 1 1/16" DP

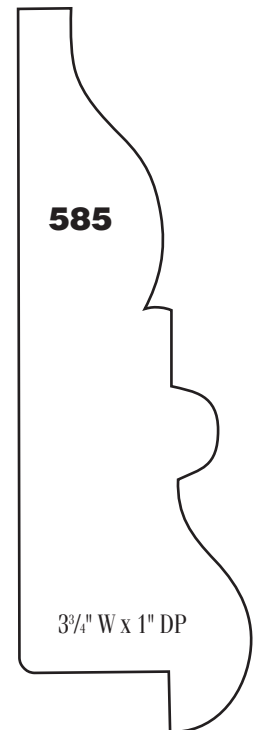

**585**

3 3/4" W X 1" DP



**418**  
1 1/4" W X 5/8" DP



**441**  
1 3/8" W X 11/16" DP



**152**  
1 3/8" W X 5/8" DP X 78" L\*



**246**  
1 3/4" W X 3/4" DP

# FLEX MOULDING, INC.

## BEADS

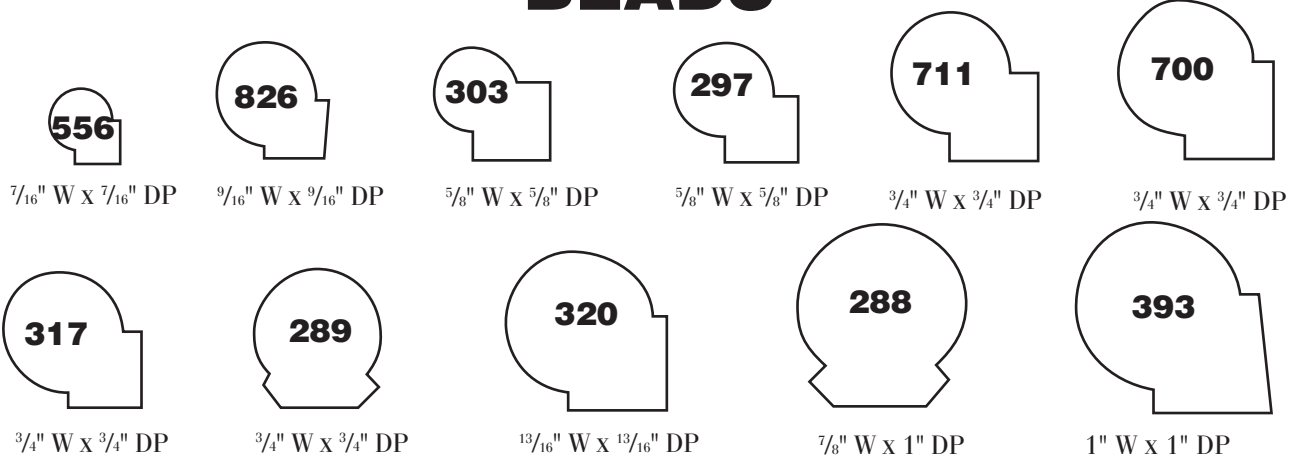

## BED

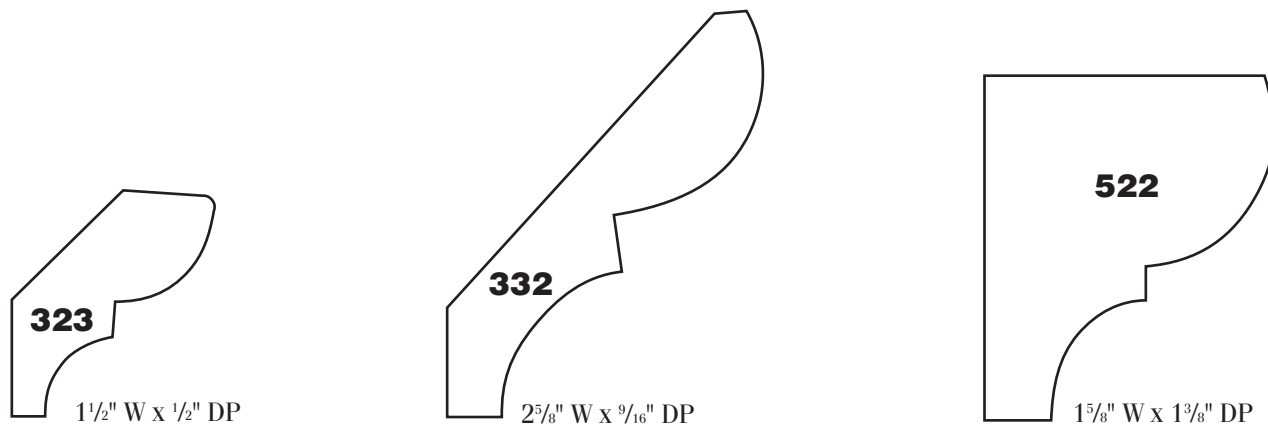

## BOLECTION

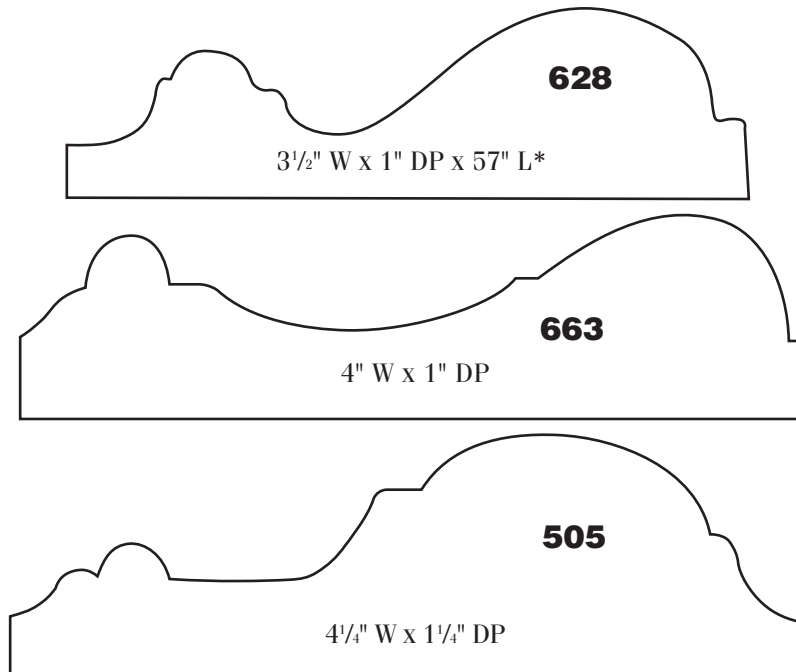

\*STANDARD IS 8' LENGTHS, EXCEPT WHERE NOTED

## BOLECTION

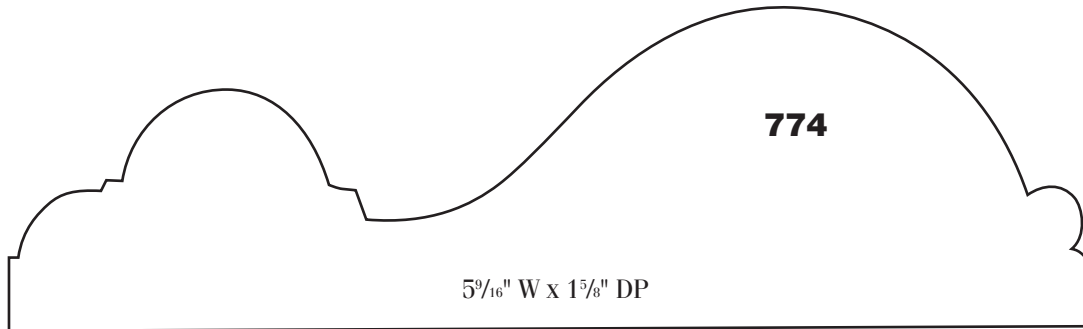
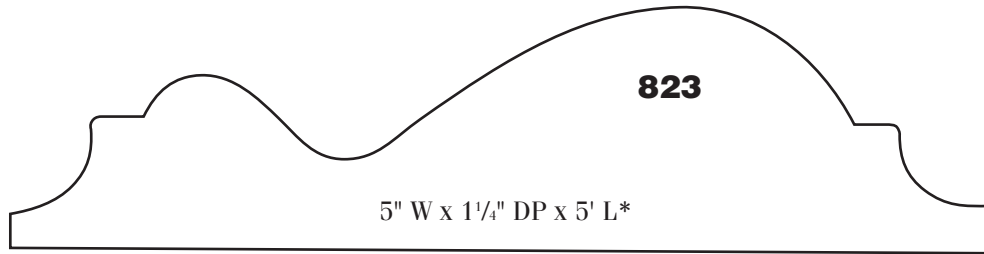

## BRICK

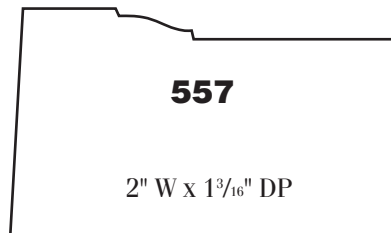

## BULLNOSE

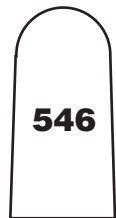

1 1/8" W x 1/2" DP



5/8" W x 1 1/8" DP x 66" L\*



1" W x 7/8" DP x 36" L\*

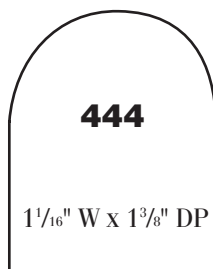

1 1/16" W x 1 3/8" DP

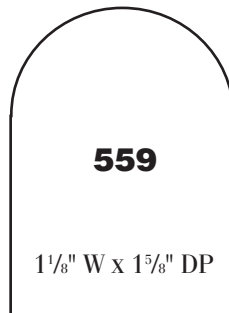

1 1/8" W x 1 5/8" DP

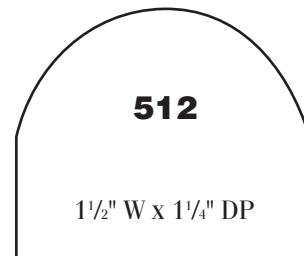

1 1/2" W x 1 1/4" DP

## CASING

**314**

1<sup>7</sup>/<sub>8</sub>" W x 1" DP x 6' L\*

**528**

2<sup>3</sup>/<sub>8</sub>" W x 1" DP

**339**

2<sup>1</sup>/<sub>8</sub>" W x <sup>7</sup>/<sub>8</sub>" DP

**595**

2<sup>3</sup>/<sub>8</sub>" W x <sup>3</sup>/<sub>4</sub>" DP

**717**

2<sup>1</sup>/<sub>8</sub>" W x 1<sup>1</sup>/<sub>4</sub>" DP

**254**

2<sup>1</sup>/<sub>2</sub>" W x <sup>9</sup>/<sub>16</sub>" DP

**378**

2<sup>1</sup>/<sub>4</sub>" W x <sup>7</sup>/<sub>8</sub>" DP

**427**

2<sup>1</sup>/<sub>2</sub>" W x <sup>5</sup>/<sub>8</sub>" DP

**253**

2<sup>1</sup>/<sub>2</sub>" W x 1<sup>1</sup>/<sub>8</sub>" DP

**846**

2<sup>1</sup>/<sub>4</sub>" W x <sup>11</sup>/<sub>16</sub>" DP

**419**

2<sup>3</sup>/<sub>4</sub>" W x <sup>3</sup>/<sub>4</sub>" DP

**367**

2<sup>1</sup>/<sub>4</sub>" W x <sup>3</sup>/<sub>4</sub>" DP

**729**

2<sup>3</sup>/<sub>4</sub>" W x <sup>1</sup>/<sub>2</sub>" DP

**438**

2<sup>1</sup>/<sub>4</sub>" W x <sup>11</sup>/<sub>16</sub>" DP

**835**

2<sup>3</sup>/<sub>4</sub>" W x 1<sup>3</sup>/<sub>4</sub>" DP

**292**

2<sup>1</sup>/<sub>4</sub>" W x 1<sup>1</sup>/<sub>8</sub>" DP

## CASING

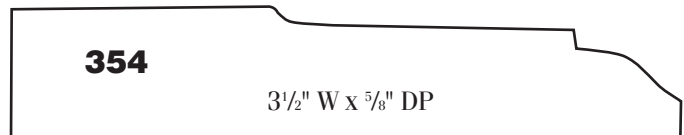
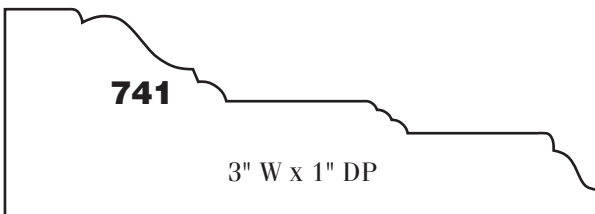
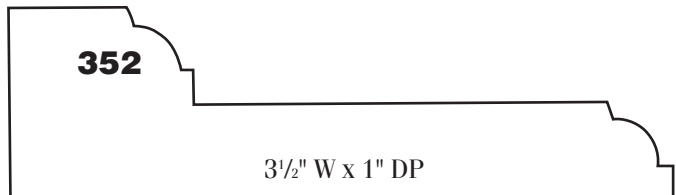
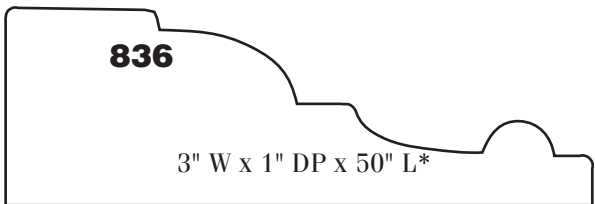
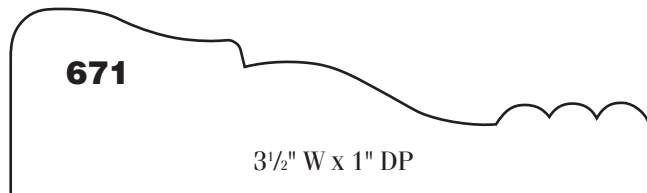
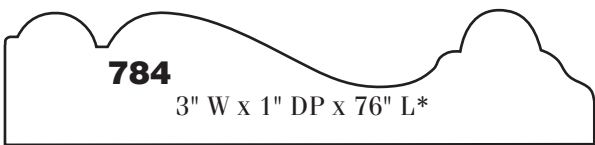
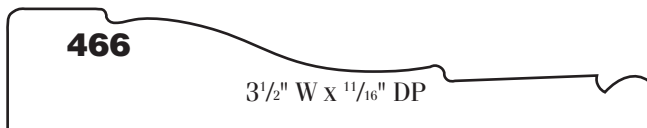
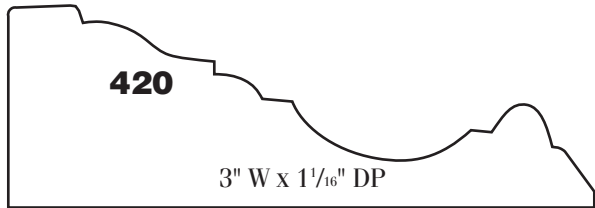
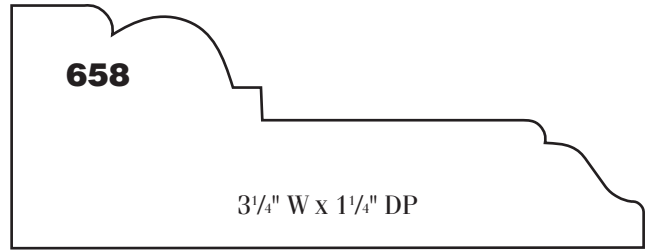
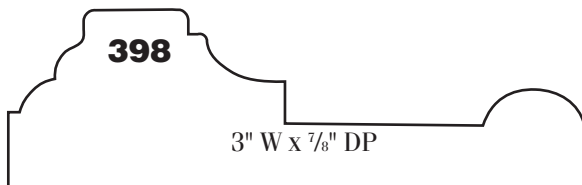
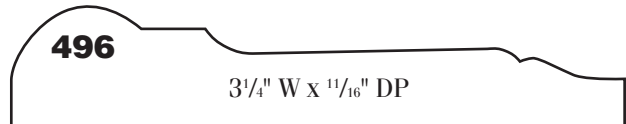
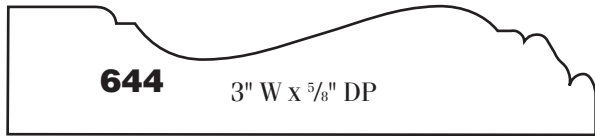
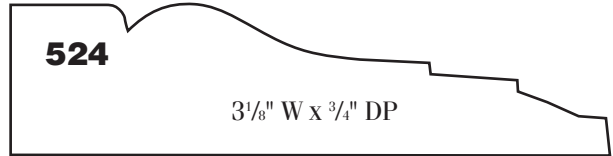
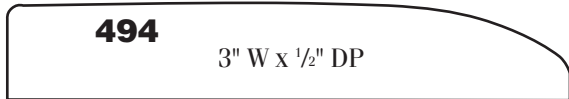
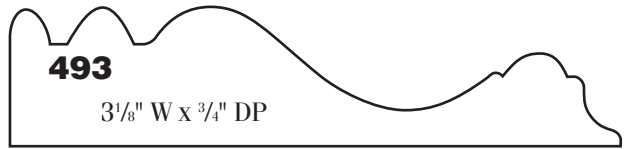
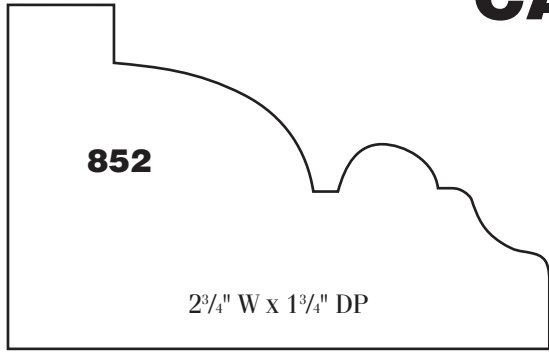



## CASING

**840**

3 1/2" W x 1 1/8" DP

**820**

3 1/2" W x 1 1/8" DP

**572**

3 1/2" W x 1" DP

**727**

3 1/2" W x 1 1/16" DP

**434**

3 1/2" W x 5/8" DP

**796**

3 1/2" W x 1 1/16" DP

**462**

3 1/2" W x 1 1/8" DP

**819**

3 1/2" W x 3/4" DP

**577**

3 1/2" W x 5/8" DP

**828**

3 1/2" W x 13/16" DP

**422**

3 1/2" W x 5/8" DP

**676**

3 1/2" W x 13/16" DP

**847**

3 1/2" W x 1" DP

**471**

3 1/2" W x 1 1/16" DP

**681**

3 1/2" W x 13/16" DP

**689**

3 1/2" W x 13/16" DP

**388**

3 1/2" W x 5/8" DP

## CASING

**679**

$3\frac{9}{16}$ " W x  $1\frac{1}{16}$ " DP

**827**

$3\frac{5}{8}$ " W x  $1\frac{1}{16}$ " DP

**674**

$3\frac{9}{16}$ " W x  $\frac{3}{4}$ " DP

**731**

$3\frac{1}{2}$ " W x 1" DP

**491**

$3\frac{7}{8}$ " W x  $1\frac{1}{8}$ " DP

**492**

$3\frac{7}{8}$ " W x  $\frac{3}{4}$ " DP

**498**

4" W x 1" DP

**639**

4" W x 1" DP

**580**

$4\frac{1}{8}$ " W x 1" DP

**541**

$4\frac{1}{8}$ " W x  $1\frac{1}{8}$ " DP

**672**

$4\frac{1}{8}$ " W x  $1\frac{3}{16}$ " DP

**293**

4" W x  $1\frac{1}{2}$ " DP

## CASING

**652**

4" W x 1" DP

**624**

4" W x 1<sup>3</sup>/<sub>4</sub>" DP

**797**

4<sup>1</sup>/<sub>16</sub>" W x 1<sup>1</sup>/<sub>16</sub>" DP

**834**

4<sup>1</sup>/<sub>8</sub>" W x 1<sup>5</sup>/<sub>8</sub>" DP x 50" L\*

**486**

4<sup>1</sup>/<sub>4</sub>" W x 1<sup>1</sup>/<sub>16</sub>" DP

**593**

4<sup>1</sup>/<sub>4</sub>" W x 7<sup>7</sup>/<sub>8</sub>" DP

**780**

4<sup>3</sup>/<sub>16</sub>" W x 1" DP

**766**

4<sup>1</sup>/<sub>4</sub>" W x 1" DP

**467**

4<sup>1</sup>/<sub>4</sub>" W x 1<sup>1</sup>/<sub>16</sub>" DP

**788**

4<sup>5</sup>/<sub>16</sub>" W x 1<sup>9</sup>/<sub>16</sub>" DP

\*STANDARD IS 8' LENGTHS, EXCEPT WHERE NOTED

## CASING

**684**

4<sup>1</sup>/<sub>4</sub>" W X 1<sup>1</sup>/<sub>16</sub>" DP

**618**

4<sup>3</sup>/<sub>8</sub>" W X 1" DP X 9' L\*

**555**

4<sup>1</sup>/<sub>2</sub>" W X 1<sup>5</sup>/<sub>16</sub>" DP

**683**

4<sup>1</sup>/<sub>2</sub>" W X 1<sup>3</sup>/<sub>16</sub>" DP

**843**

4<sup>7</sup>/<sub>16</sub>" W X 1<sup>3</sup>/<sub>16</sub>" DP

**694**

4<sup>1</sup>/<sub>2</sub>" W X 3/4" DP

**811**

4<sup>1</sup>/<sub>2</sub>" W X 1" DP

**497**

**685**

4<sup>5</sup>/<sub>8</sub>" W X 1<sup>1</sup>/<sub>16</sub>" DP

4<sup>5</sup>/<sub>8</sub>" W X 1<sup>1</sup>/<sub>8</sub>" DP

**571**

**802**

4<sup>5</sup>/<sub>8</sub>" W X 1" DP

4<sup>1</sup>/<sub>16</sub>" W X 1<sup>1</sup>/<sub>16</sub>" DP

## CASING

**682**

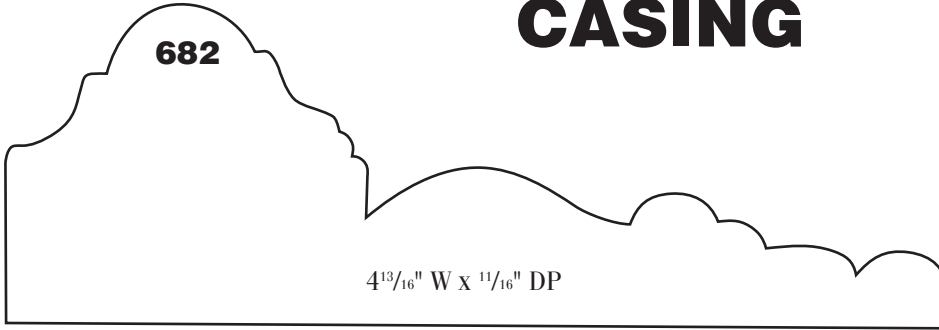

**646**

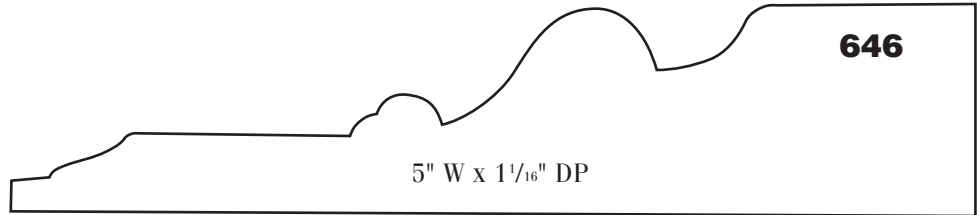

**781**

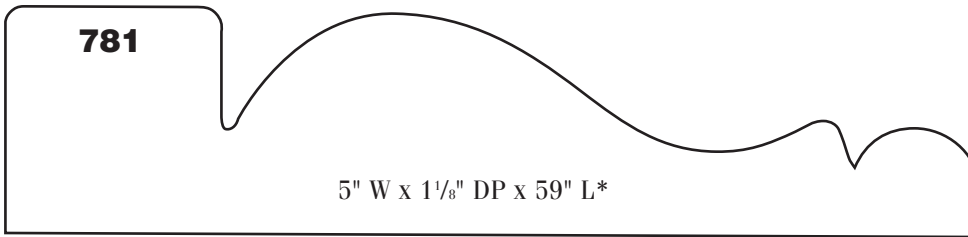

**645**

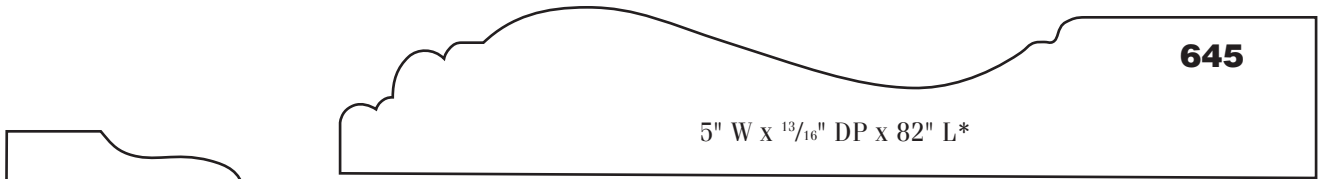

**579**

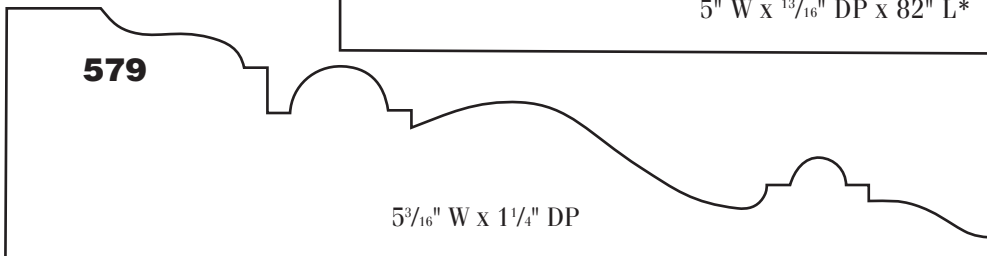

**359**

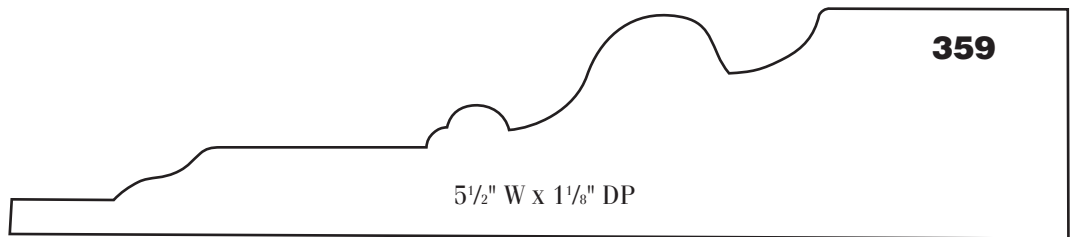

**786**

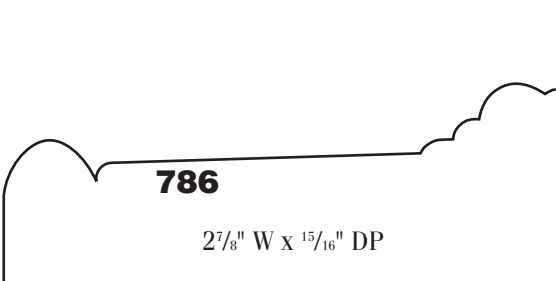

**785**

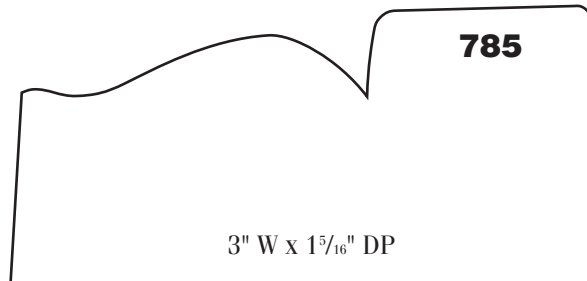

\*STANDARD IS 8' LENGTHS, EXCEPT WHERE NOTED

## CASING

**833**

6" W x 1<sup>5</sup>/<sub>8</sub>" DP x 50" L\*

**561**

6<sup>3</sup>/<sub>4</sub>" W x 1<sup>3</sup>/<sub>4</sub>" DP

**795**

7<sup>1</sup>/<sub>8</sub>" W x 1<sup>1</sup>/<sub>16</sub>" DP

## CHAIR RAIL

**735**

2<sup>1</sup>/<sub>4</sub>" W x 1" DP

**703**

2<sup>5</sup>/<sub>16</sub>" W x 3<sup>3</sup>/<sub>4</sub>" DP  
x 4' L\*

**553**

2<sup>1</sup>/<sub>2</sub>" W x 9<sup>9</sup>/<sub>16</sub>" DP

**756**

2<sup>1</sup>/<sub>2</sub>" W x 9<sup>9</sup>/<sub>16</sub>" DP

**604**

2<sup>1</sup>/<sub>2</sub>" W x 1<sup>1</sup>/<sub>16</sub>" DP

**777**

2<sup>5</sup>/<sub>8</sub>" W x 3<sup>3</sup>/<sub>4</sub>" DP

**CHAIR RAIL**

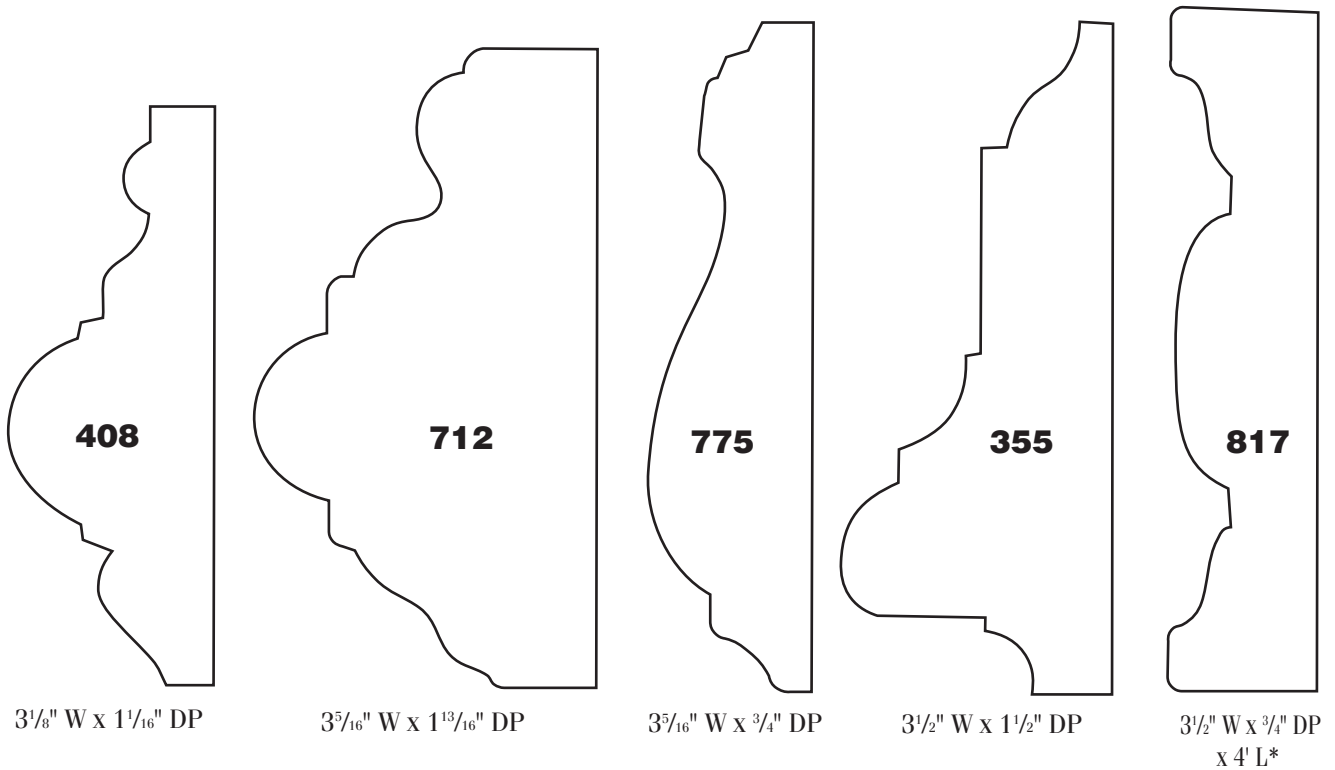
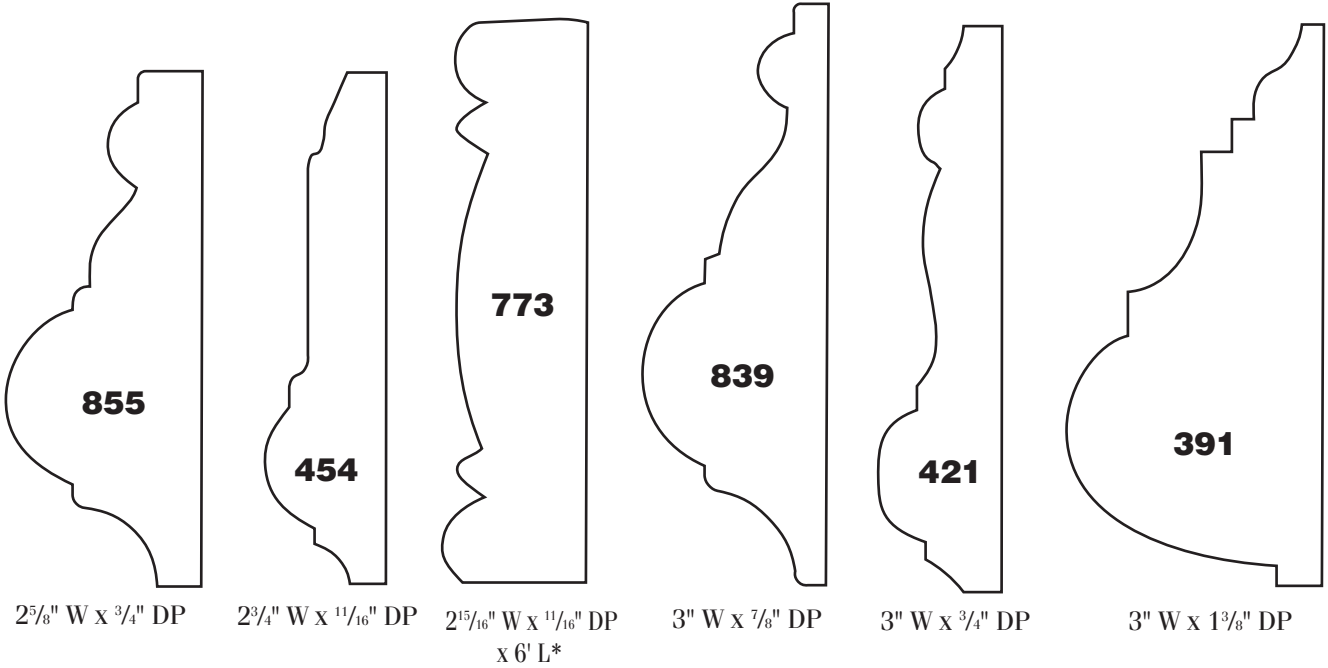

\*STANDARD IS 8' LENGTHS, EXCEPT WHERE NOTED

## CHAIR RAIL

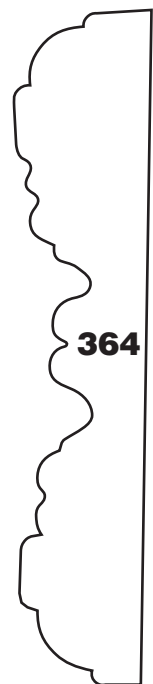

**364**

3 1/2" W x 1 1/16" DP  
x 78" L\*

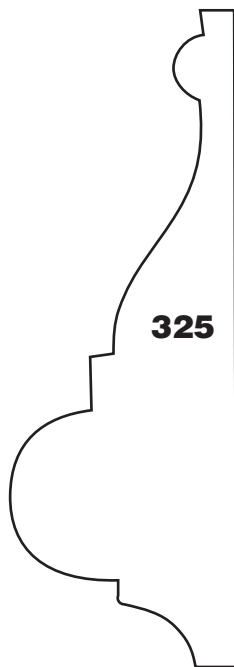

**325**

3 7/16" W x 1 1/8" DP



**666**

3 9/16" W x 1 1/16" DP

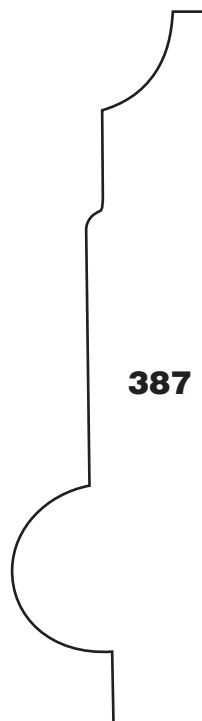

**387**

3 3/4" W x 1" DP

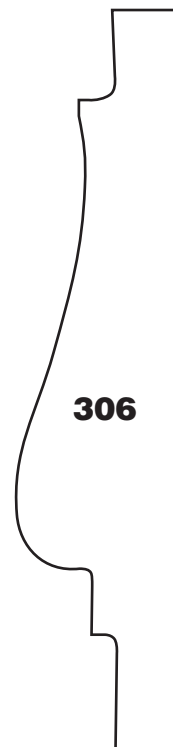

**306**

4" W x 7/8" DP  
x 4' L\*

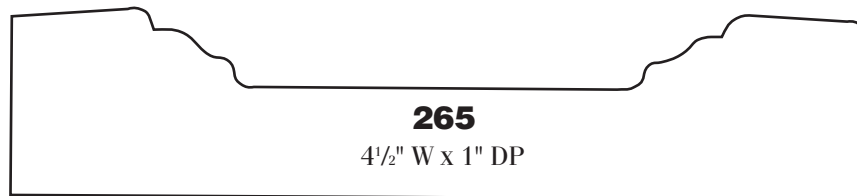

**265**

4 1/2" W x 1" DP



**276**

6" W x 1/2" DP x 51" L\*

## CHAMFER STRIP



**616**

1" W x 1/2" DP



**621**

1 5/8" W x 3/8" DP

## CORNER GUARDS



**431**

3/4" W x 3/4" DP



**670**

7/8" W x 7/8" DP

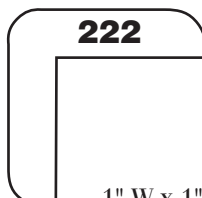

**222**

1" W x 1" DP

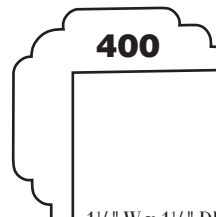

**400**

1 1/8" W x 1 1/8" DP x 9' L\*

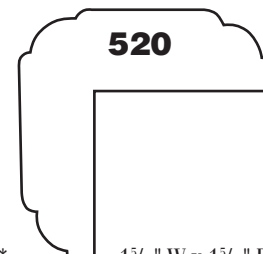

**520**

1 5/16" W x 1 5/16" DP



# FLEX MOULDING, INC.

## COVE

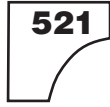

**521**

$\frac{1}{2}$ " W X  $\frac{1}{2}$ " DP

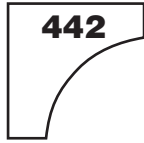

**442**

$\frac{1}{16}$ " W X  $\frac{1}{16}$ " DP

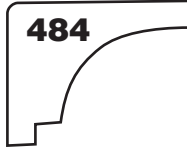

**484**

$\frac{7}{8}$ " W X  $\frac{3}{4}$ " DP

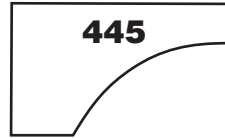

**445**

$1\frac{1}{8}$ " W X  $1\frac{1}{16}$ " DP

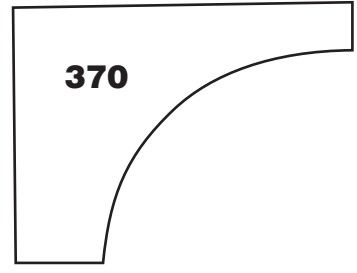

**370**

$1\frac{3}{4}$ " W X  $1\frac{3}{8}$ " DP

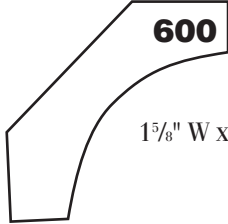

**600**

$1\frac{5}{8}$ " W X  $\frac{9}{16}$ " DP

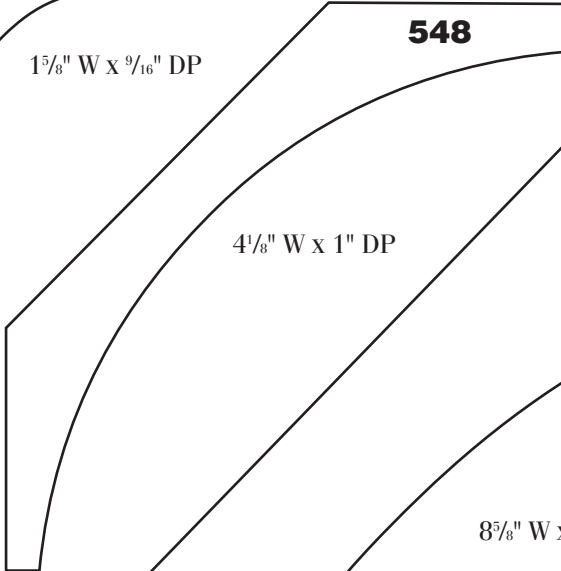

**548**

$\frac{4}{8}$ " W X 1" DP

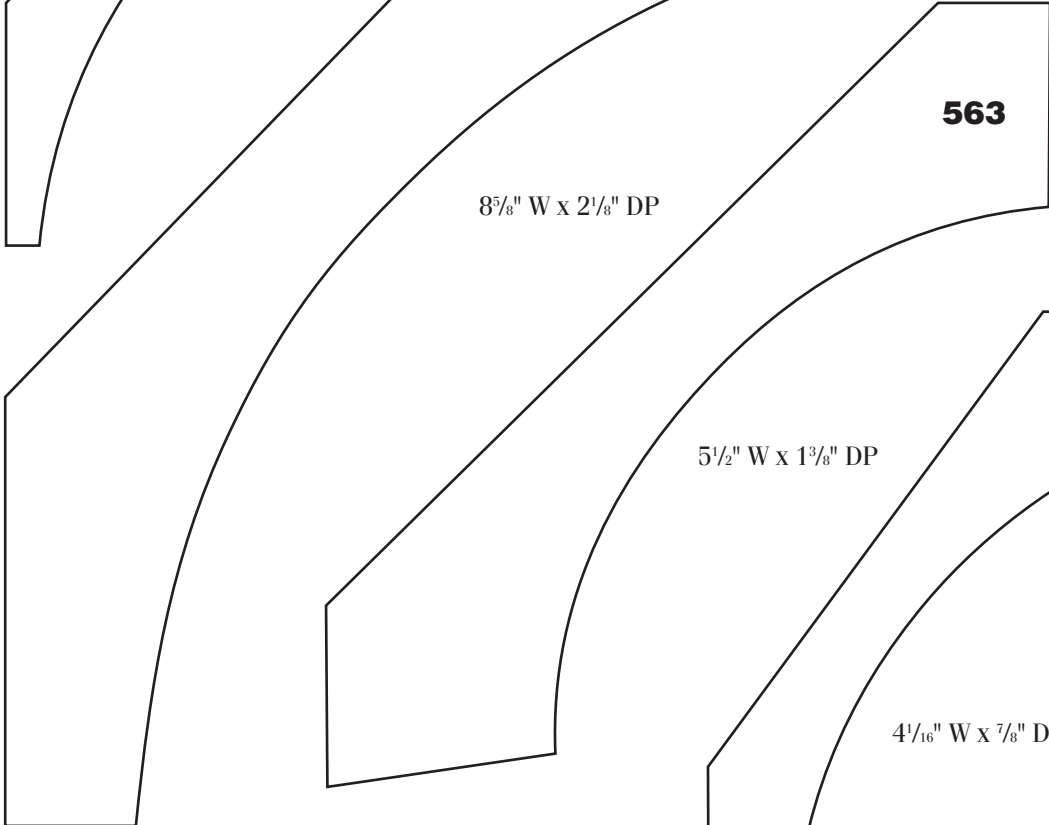

**552**

$8\frac{5}{8}$ " W X  $2\frac{1}{8}$ " DP

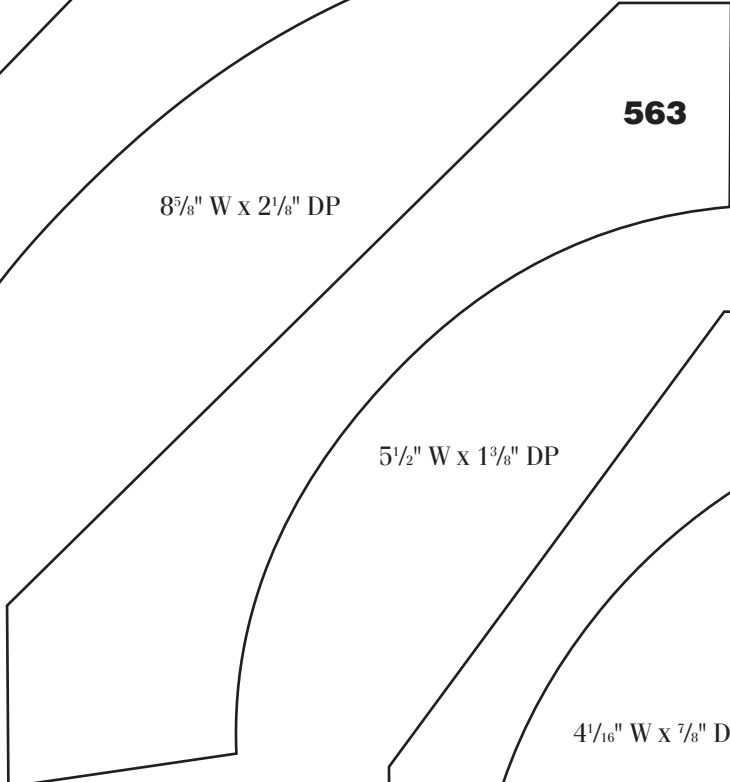

**563**

$5\frac{1}{2}$ " W X  $1\frac{3}{8}$ " DP

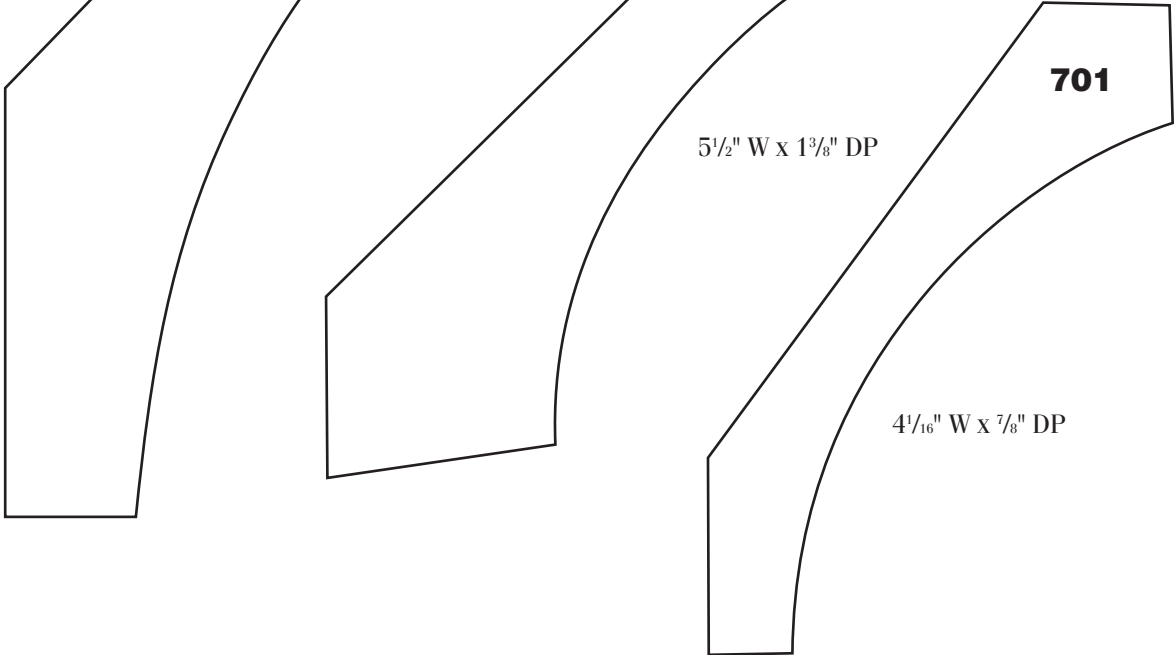

**701**

$\frac{4}{16}$ " W X  $\frac{7}{8}$ " DP

\*STANDARD IS 8' LENGTHS, EXCEPT WHERE NOTED

## CROWN

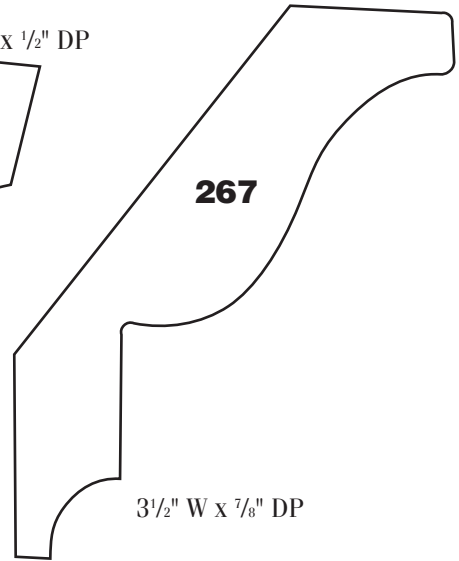
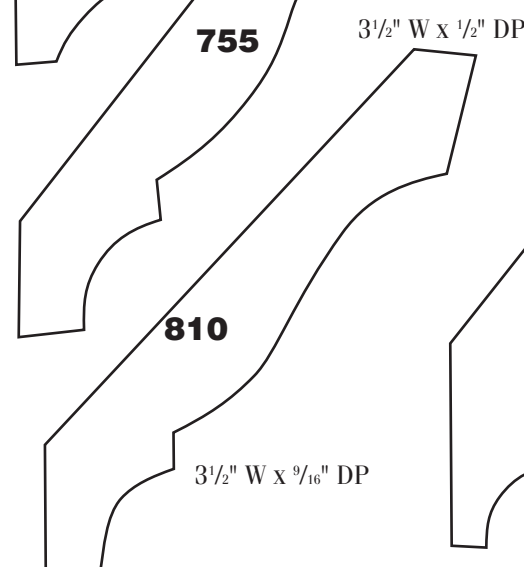
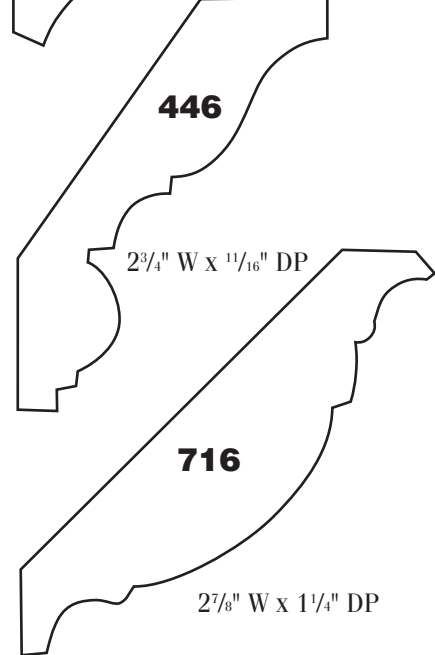
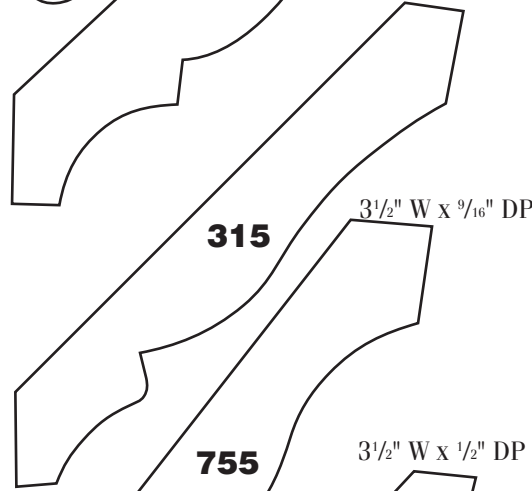
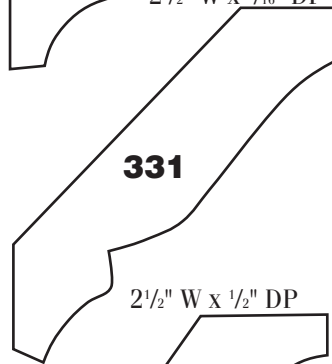
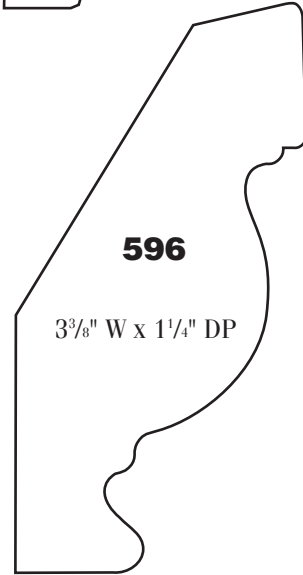
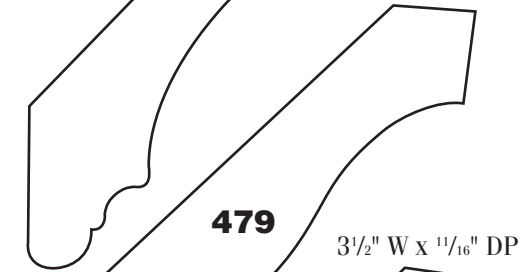
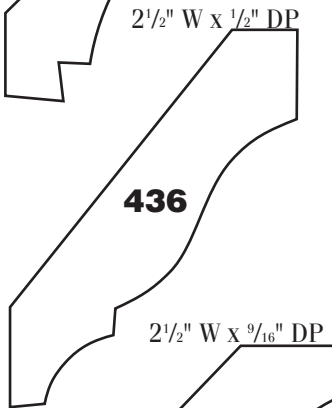
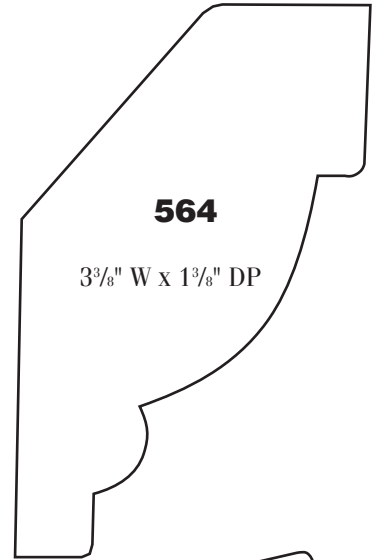
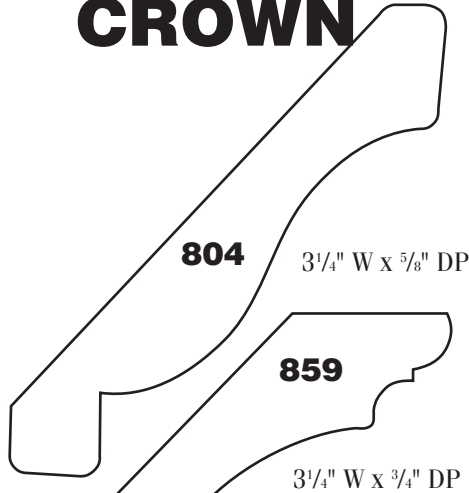
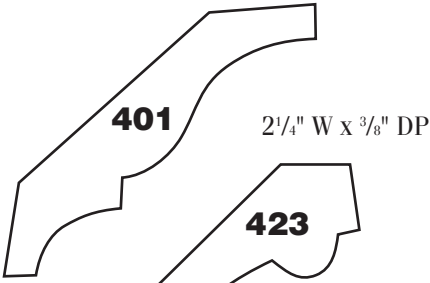

## CROWN

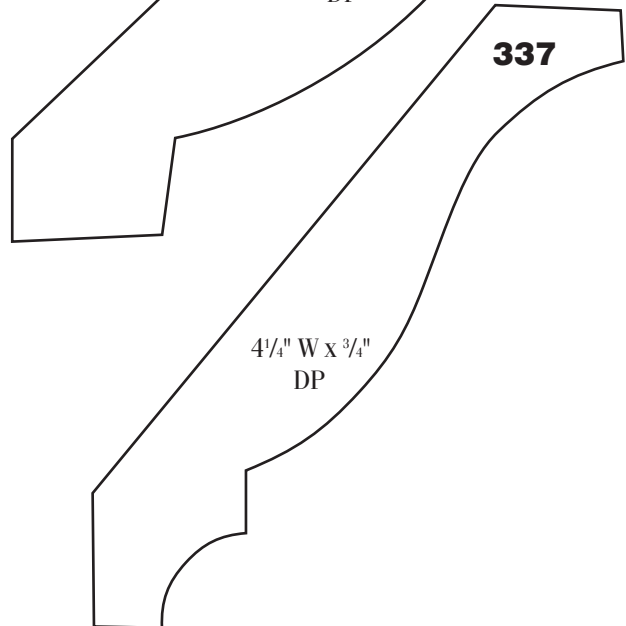
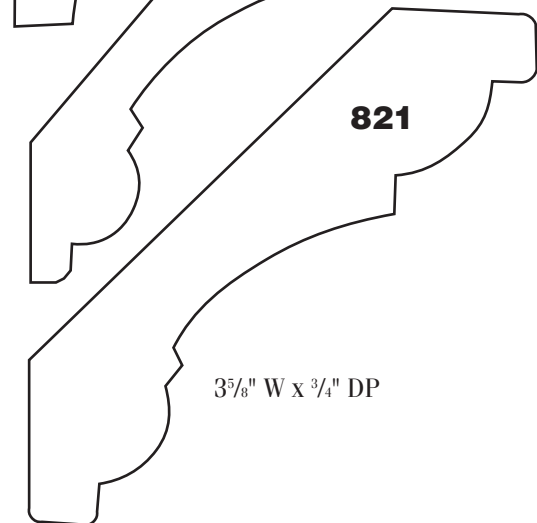
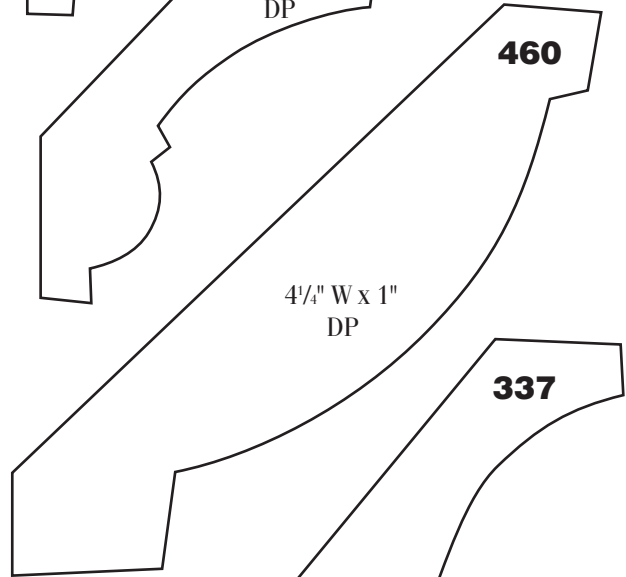
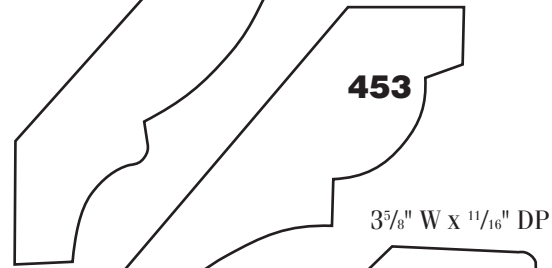
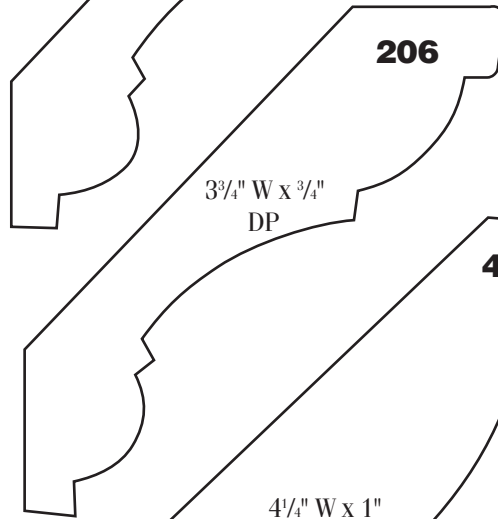
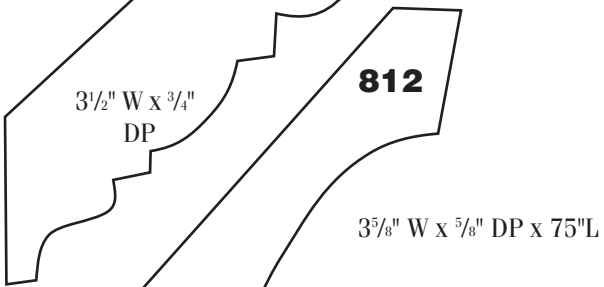
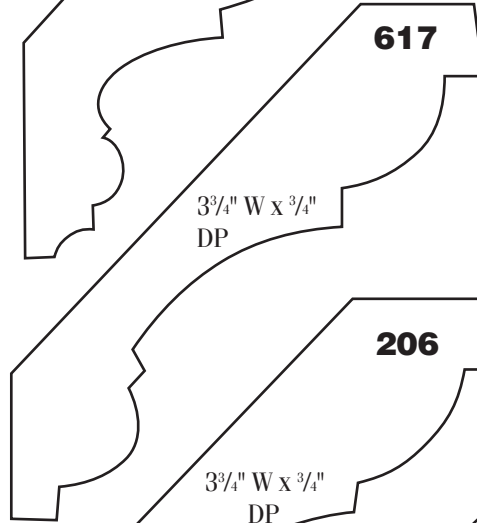
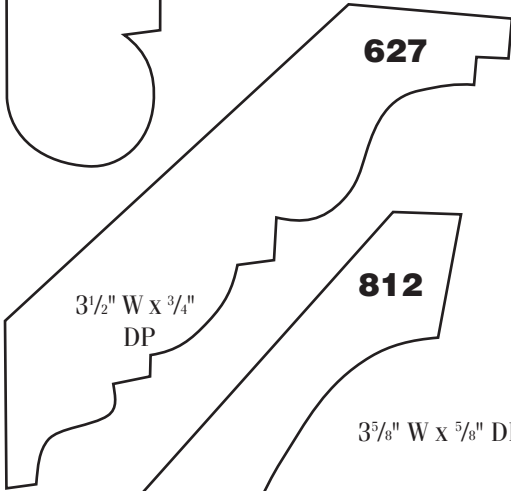
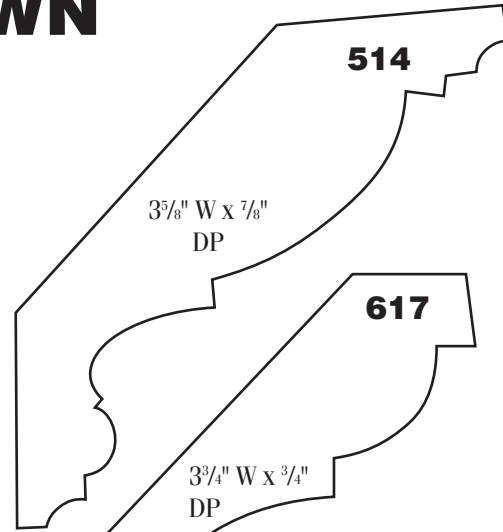
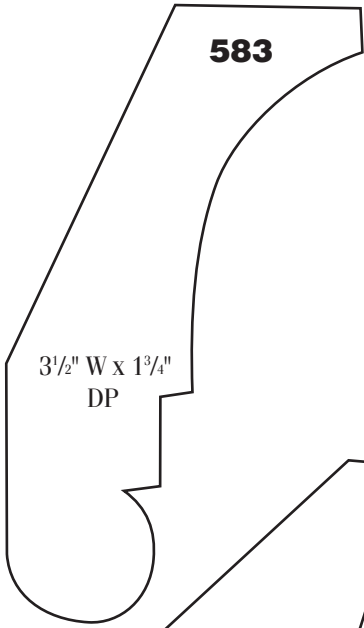

\*STANDARD IS 8' LENGTHS, EXCEPT WHERE NOTED

## CROWN

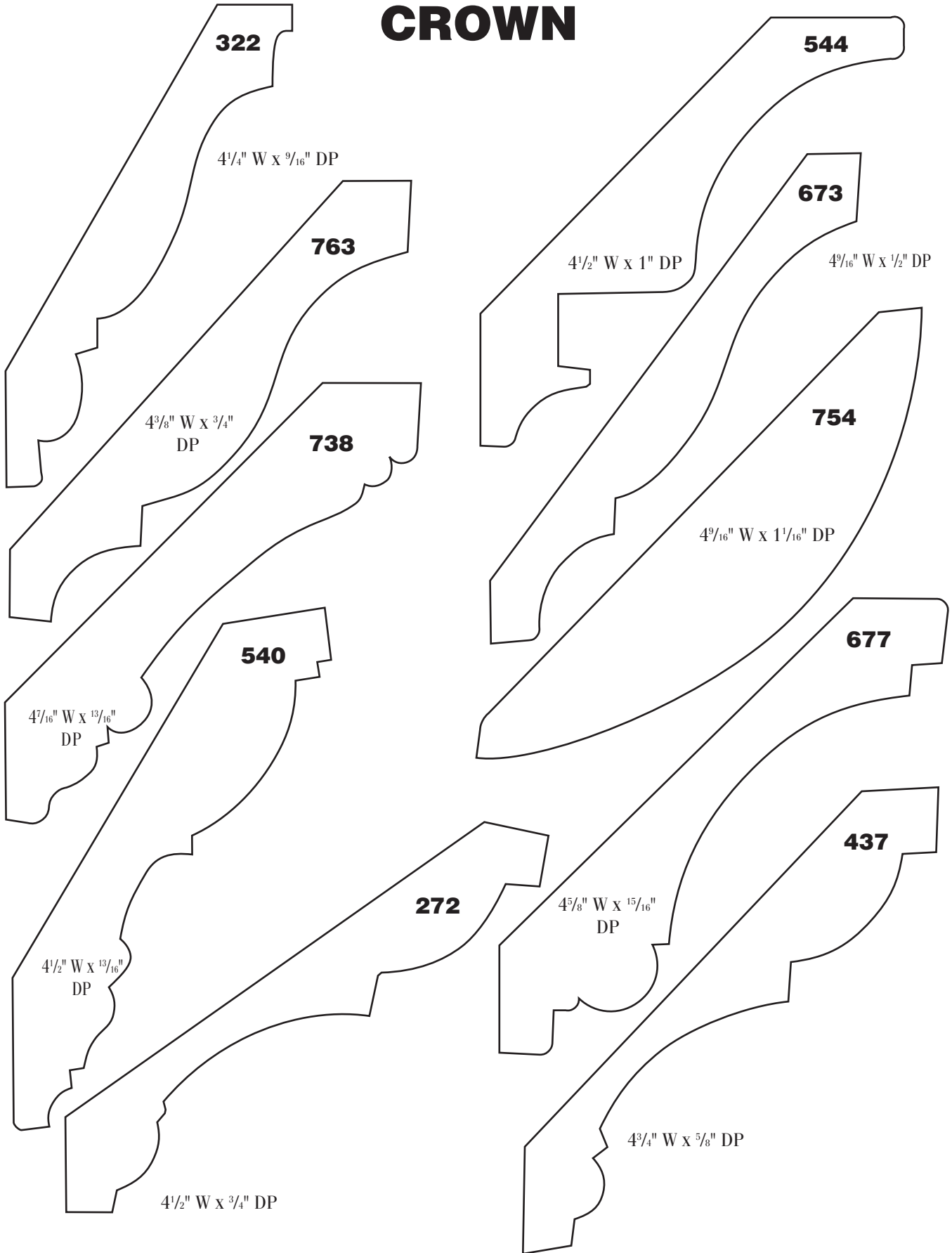

## CROWN

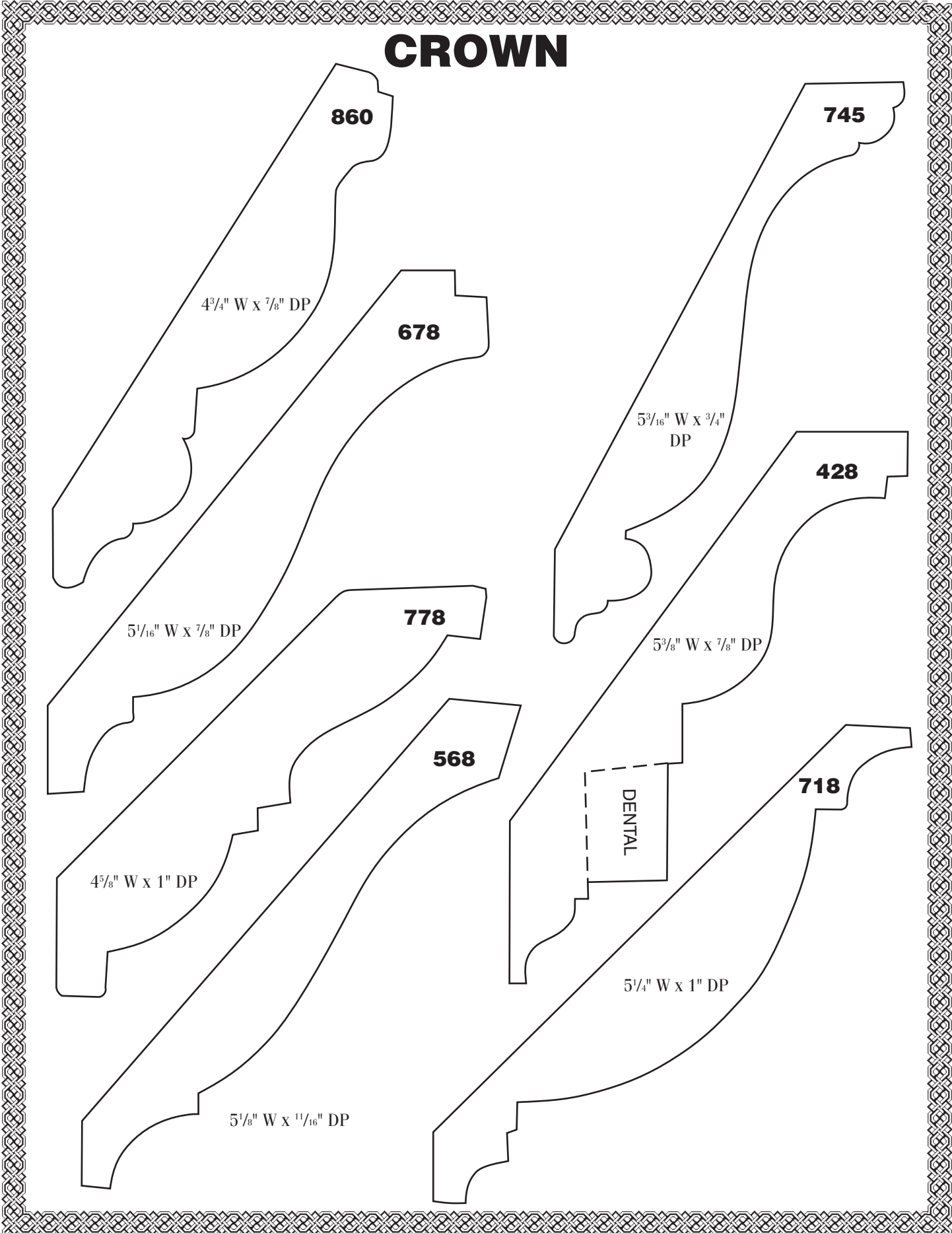

\*STANDARD IS 8' LENGTHS, EXCEPT WHERE NOTED

## CROWN

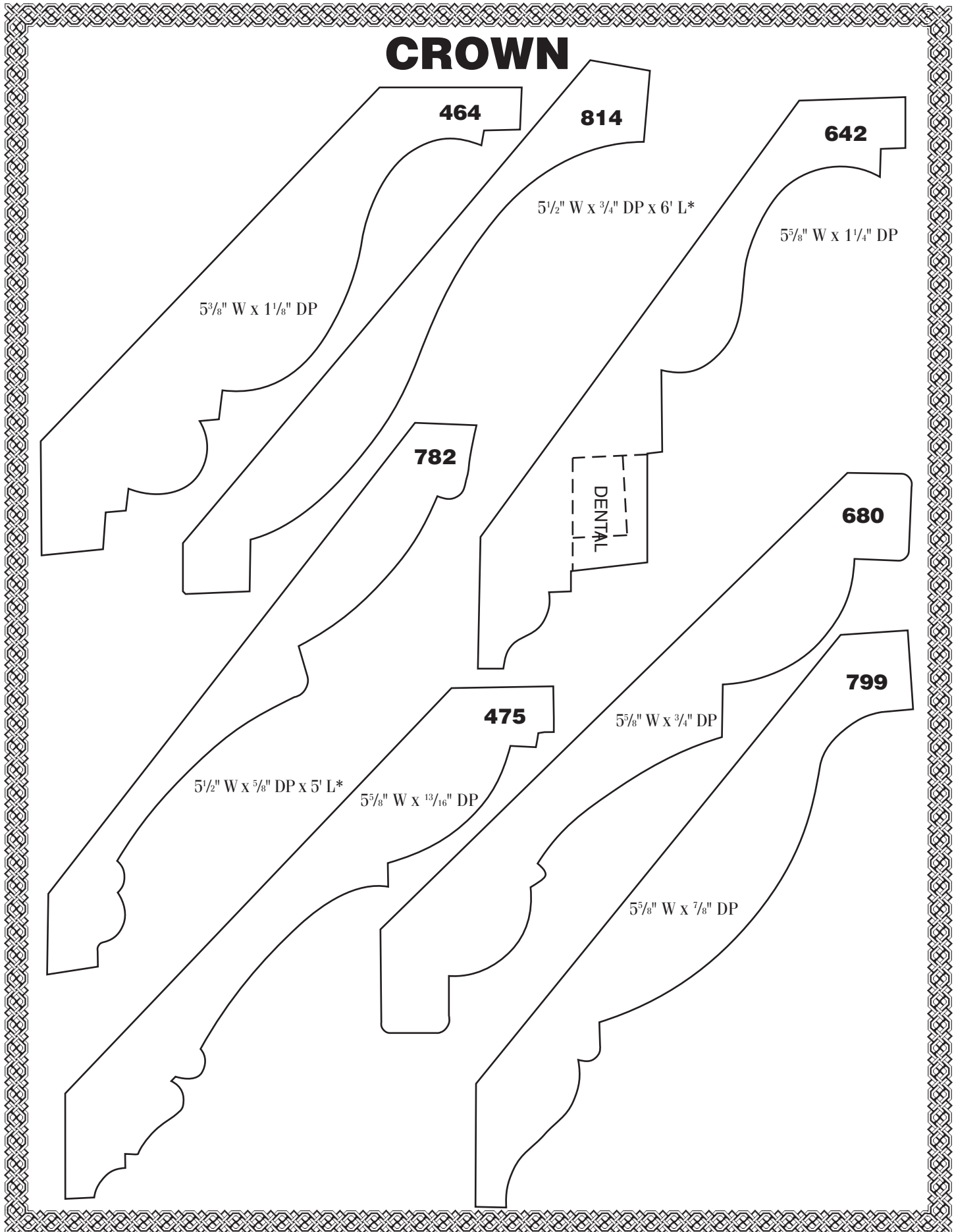

## CROWN

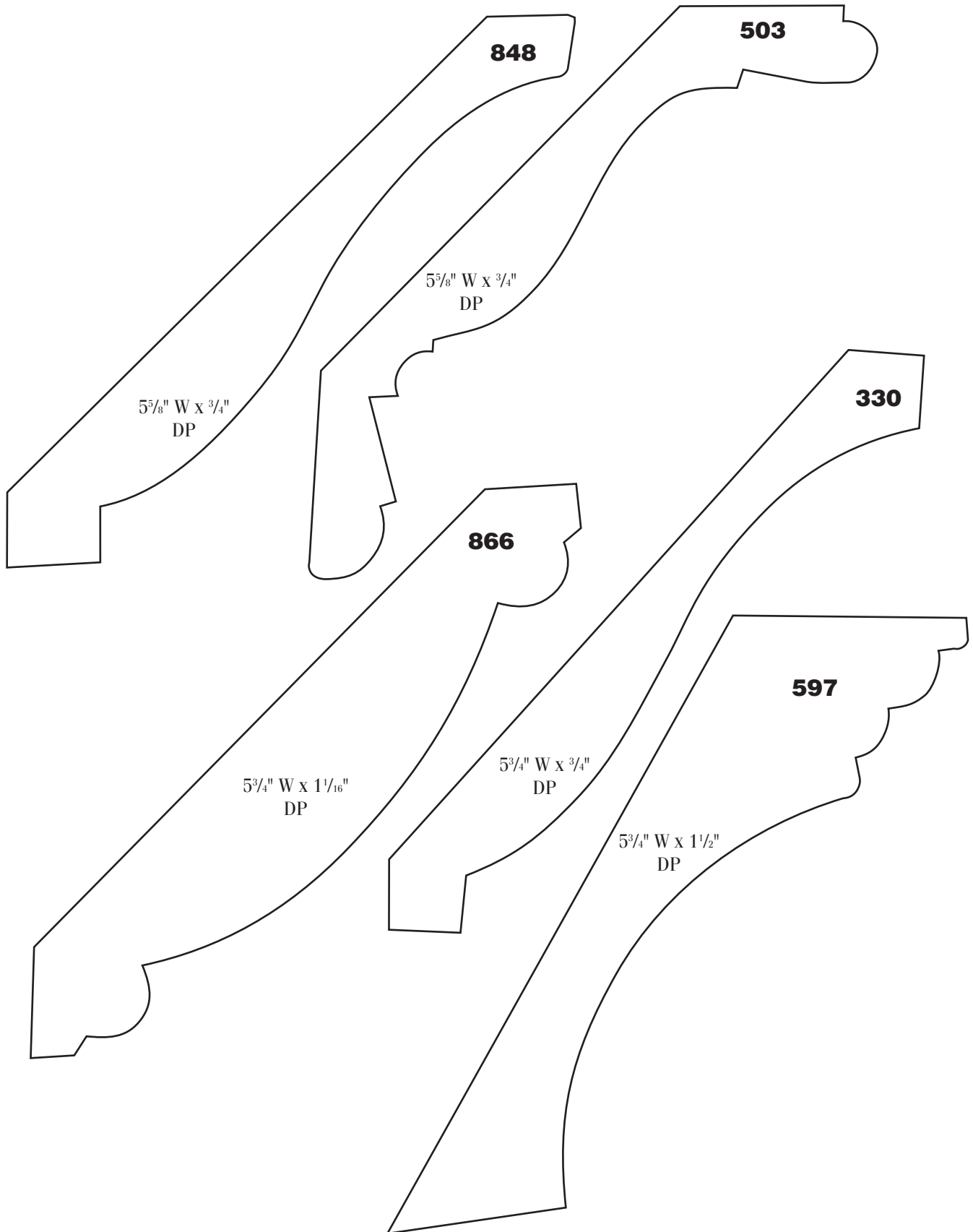

\*STANDARD IS 8' LENGTHS, EXCEPT WHERE NOTED

**CROWN**

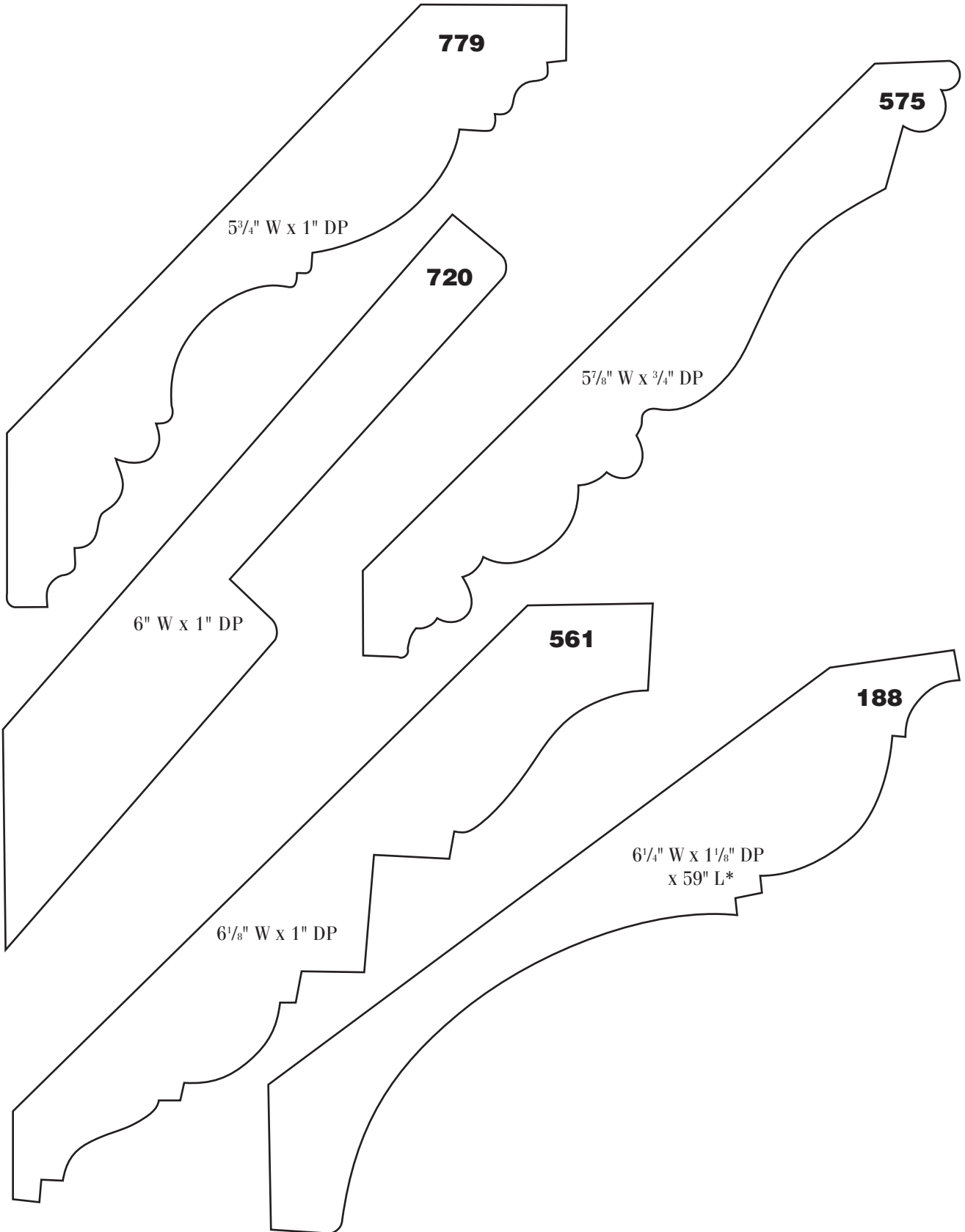



## CROWN

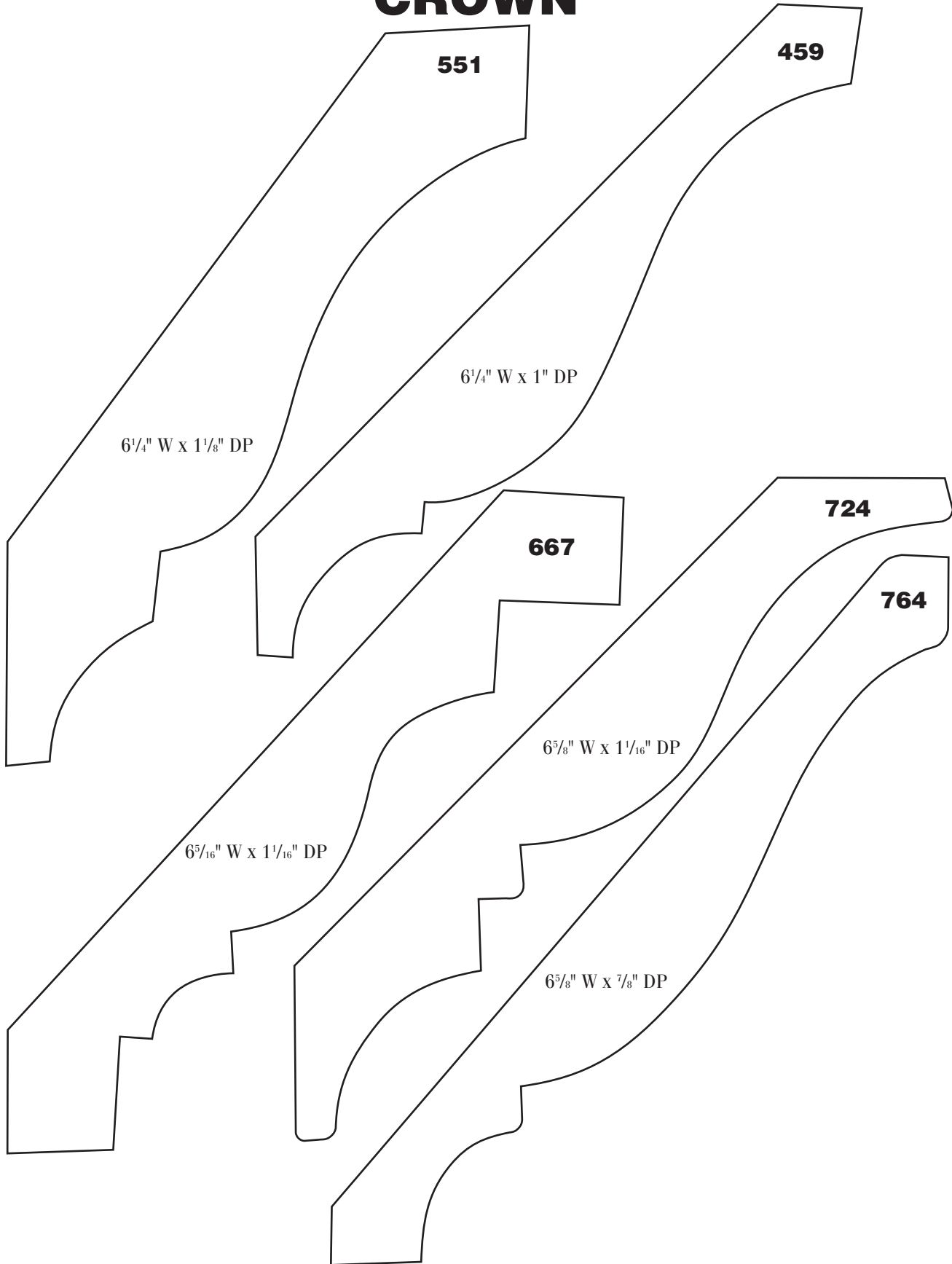

\*STANDARD IS 8' LENGTHS, EXCEPT WHERE NOTED

## CROWN

566

715

806

6<sup>5</sup>/<sub>8</sub>" W x 1<sup>1</sup>/<sub>16</sub>" DP

7" W x 3<sup>3</sup>/<sub>4</sub>" DP

704

6<sup>3</sup>/<sub>4</sub>" W x 1" DP

726

7<sup>1</sup>/<sub>8</sub>" W x 7<sup>7</sup>/<sub>8</sub>" DP

7<sup>1</sup>/<sub>4</sub>" W x 7<sup>1</sup>/<sub>16</sub>" DP

# FLEX MOULDING, INC.

## CROWN

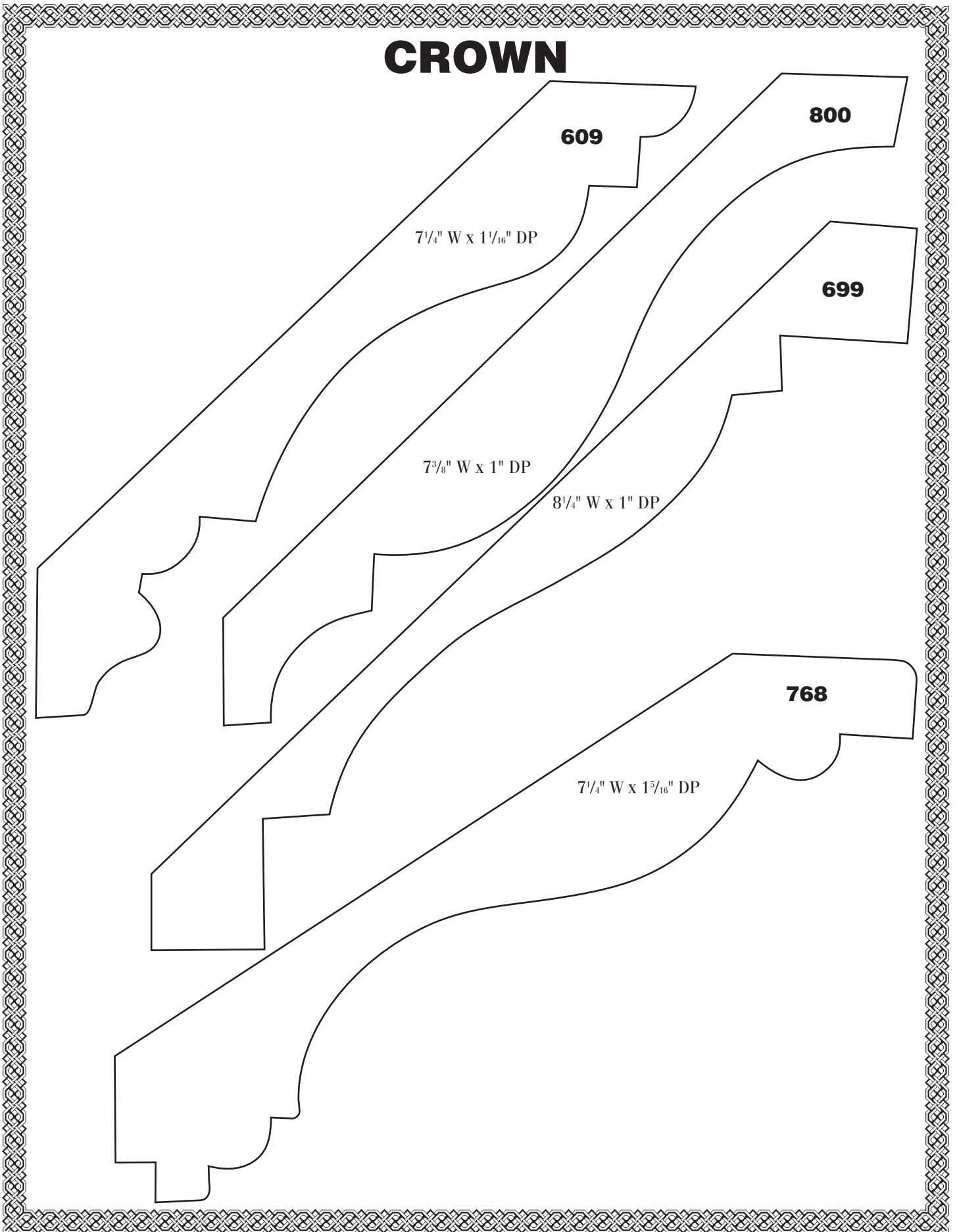

\*STANDARD IS 8' LENGTHS, EXCEPT WHERE NOTED

## CROWN

**708**

8½" W x 1⅝" DP

**709**

2¼" W x 1⅞" DP

**719**

9" W x ¾" DP

## CROWN (SOLID)

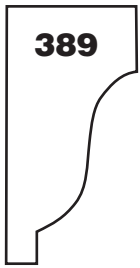

**389**

$1\frac{3}{8}$ " W x  $\frac{5}{8}$ " DP



**511**

$1\frac{3}{8}$ " W x  $\frac{5}{8}$ " DP

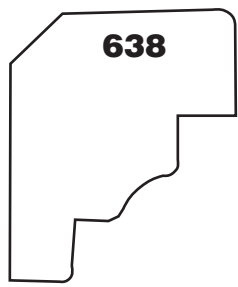

**638**

$1\frac{3}{8}$ " W x  $1\frac{1}{8}$ " DP

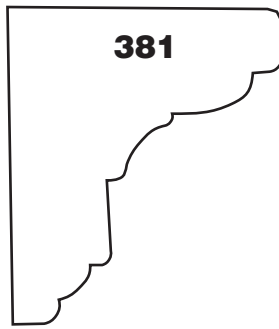

**381**

$1\frac{5}{8}$ " W x  $1\frac{1}{2}$ " DP  
x 5" L\*



**468**

$1\frac{3}{4}$ " W x  $\frac{3}{4}$ " DP

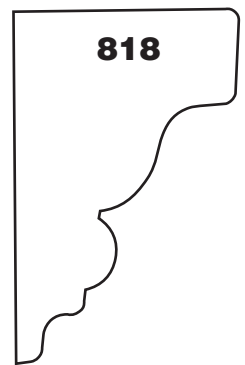

**818**

$1\frac{3}{4}$ " W x  $1\frac{1}{8}$ " DP



**501**

$1\frac{3}{4}$ " W x  $\frac{11}{16}$ " DP



**477**

$1\frac{3}{4}$ " W x  $\frac{7}{8}$ " DP

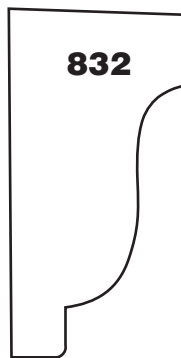

**832**

$1\frac{3}{4}$ " W x  $\frac{7}{8}$ " DP

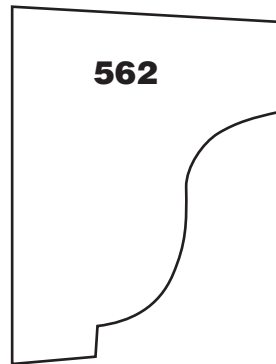

**562**

$1\frac{7}{8}$ " W x  $1\frac{3}{8}$ " DP

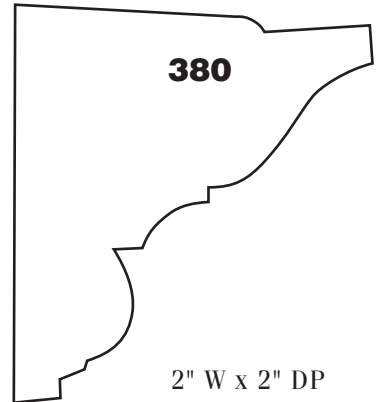

**380**

2" W x 2" DP  
x 7" L\*

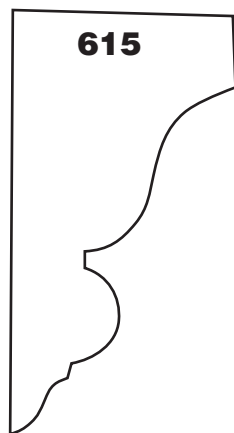

**615**

$2\frac{1}{4}$ " W x  $1\frac{1}{8}$ " DP

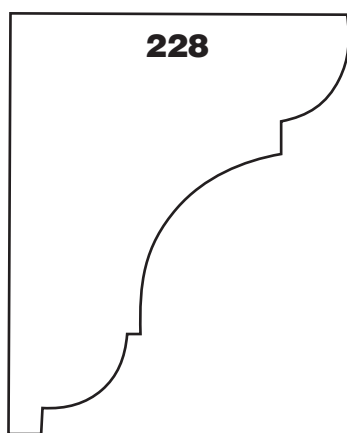

**228**

$2\frac{1}{4}$ " W x  $1\frac{3}{4}$ " DP

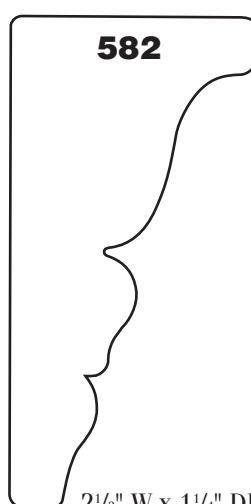

**582**

$2\frac{1}{2}$ " W x  $1\frac{1}{4}$ " DP

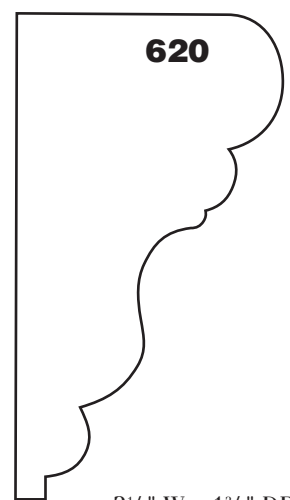

**620**

$2\frac{1}{2}$ " W x  $1\frac{3}{8}$ " DP

## CROWN (SOLID)

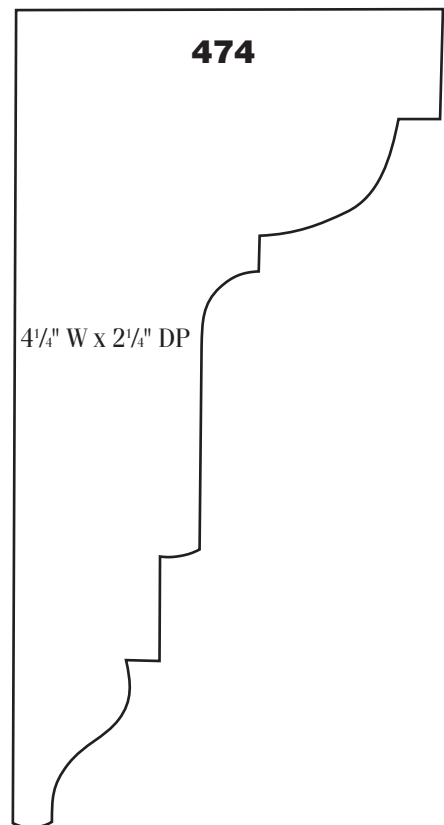
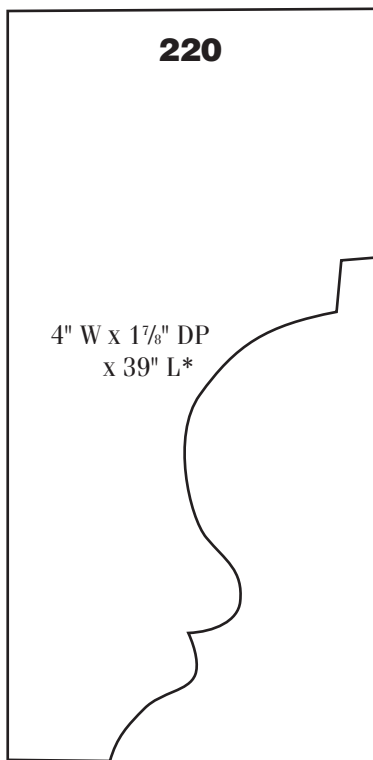
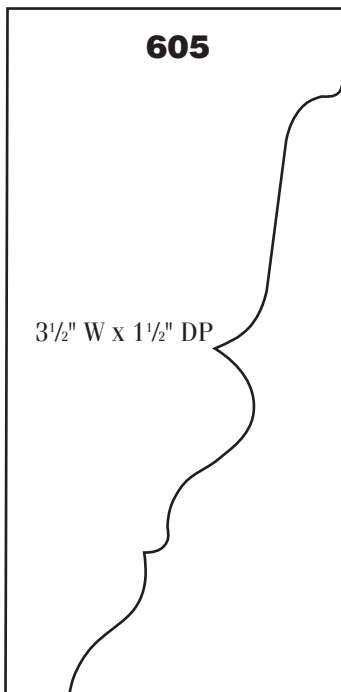
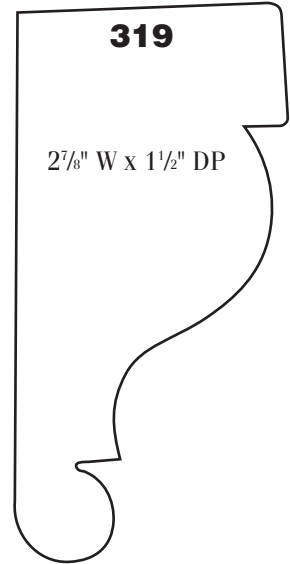
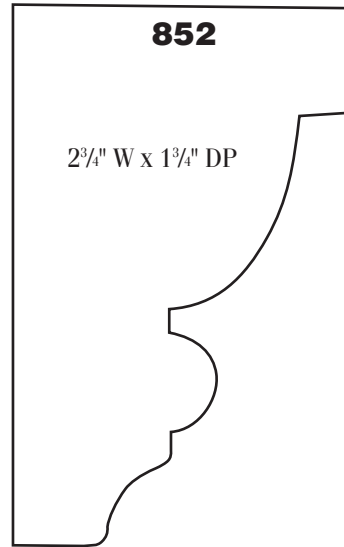
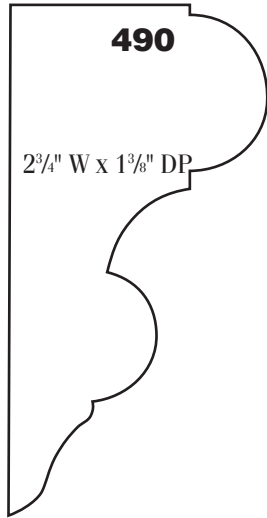
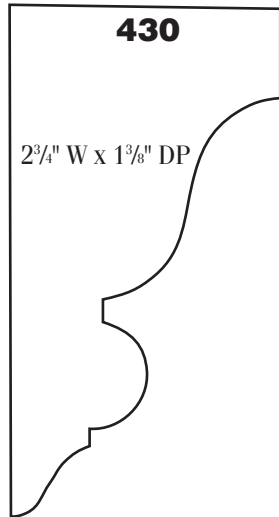

## CROWN (SOLID)

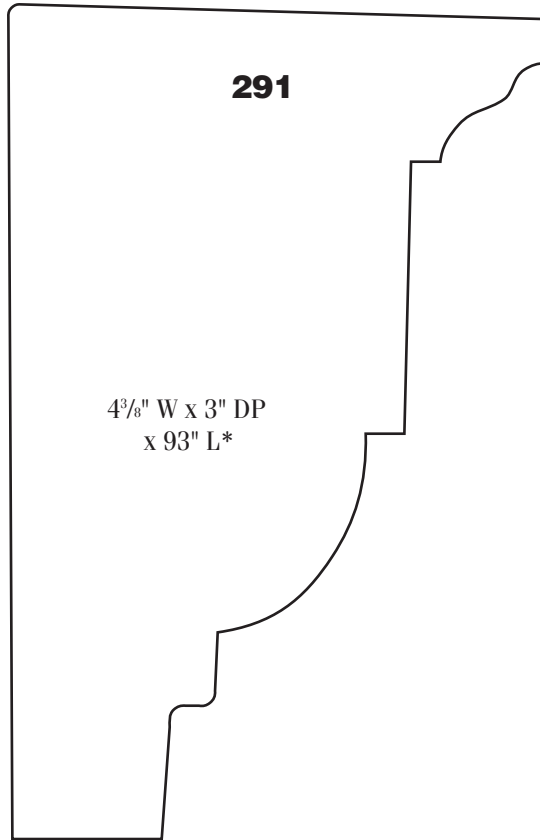
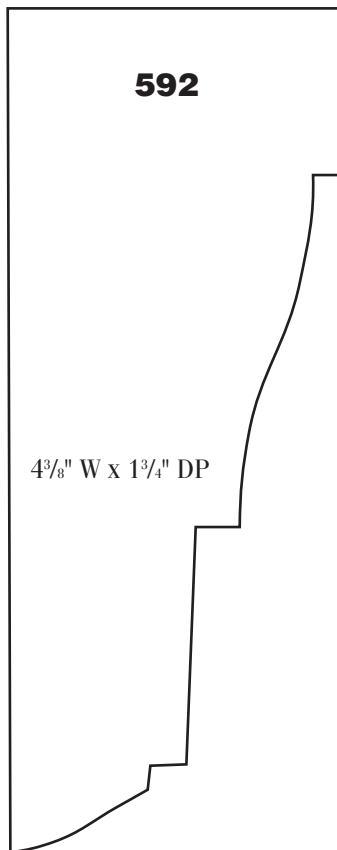

## GLASS BEAD

**636**



1/4" W X 1/4" DP

**168**



3/8" W X 1/4" DP

**637**



3/8" W X 1/4" DP



**825**

3/8" W X 3/8" DP  
X 48" L\*



**495**

1/2" W X 3/8" DP

**849**



1/2" W X 1/4" DP



**614**

1/2" W X 3/8" DP



**361**

9/16" W X 3/8" DP X 6' L\*



**664**

5/8" W X 5/16" DP

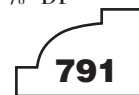

**791**

5/8" W X 7/16" DP

## HALF ROUND

**130**



3/8" W X 3/16" DP

**483**



1/2" W X 1/4" DP

**257**



1/2" W X 1/4" DP

**240**



5/8" W X 1/4" DP

**256**



5/8" W X 5/16" DP

**316**



1" W X 1/2" DP

**603**

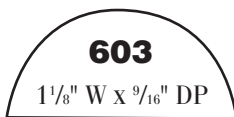

1 1/8" W X 9/16" DP

**599**

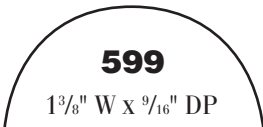

1 3/8" W X 9/16" DP

**248**

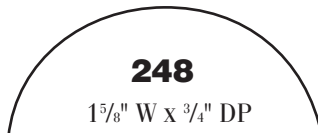

1 5/8" W X 3/4" DP

**473**

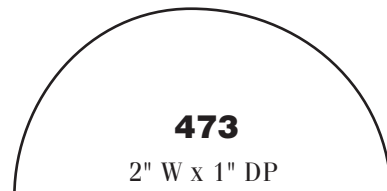

2" W X 1" DP

## HALF ROUND

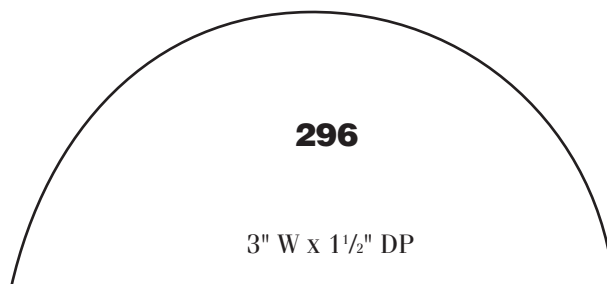
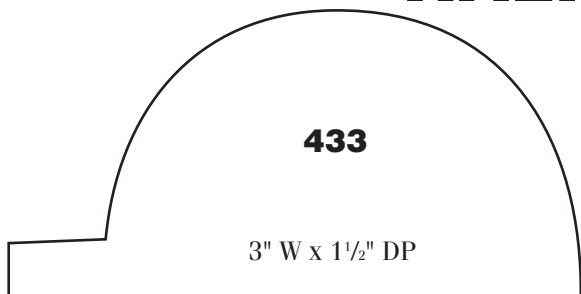

## HAND RAIL

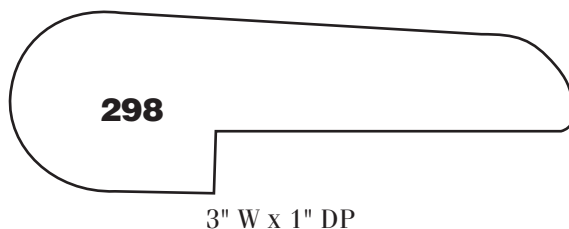
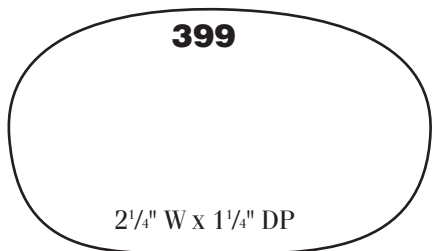

## MISCELLANEOUS

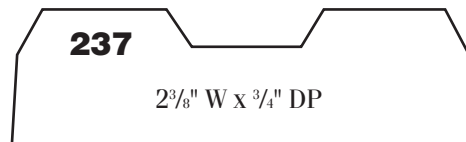
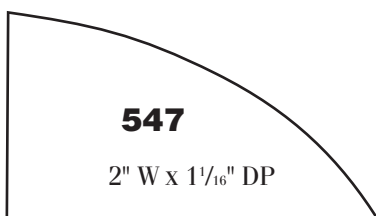
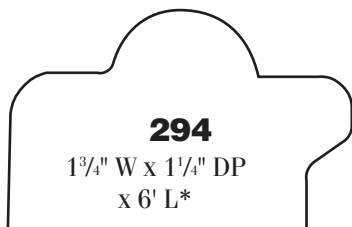
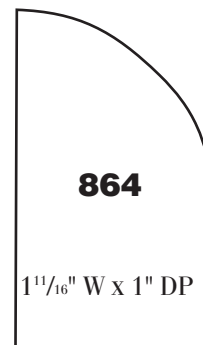
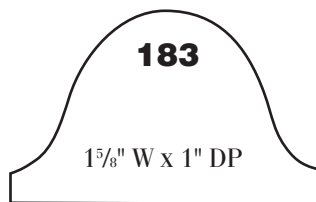
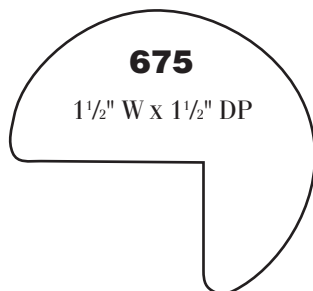
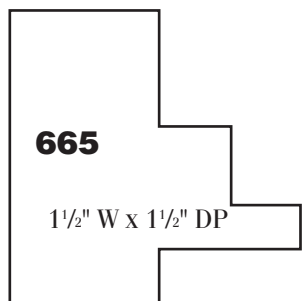
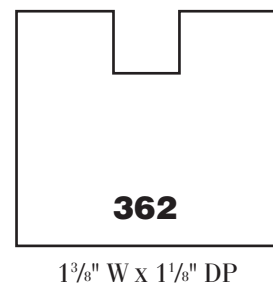
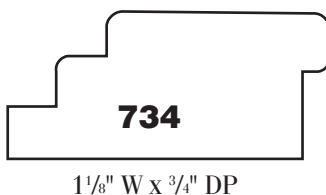
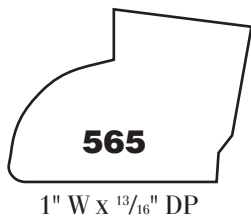
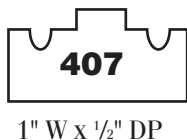



## MISCELLANEOUS

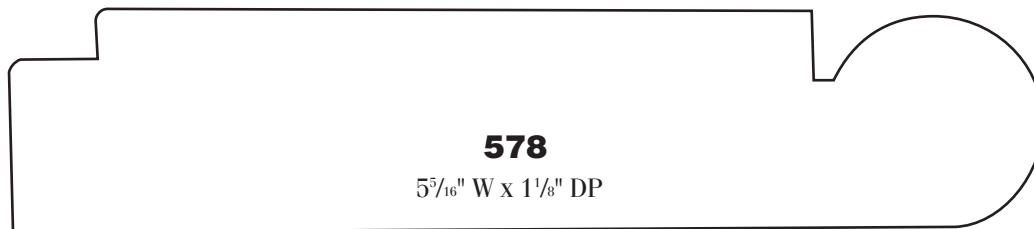
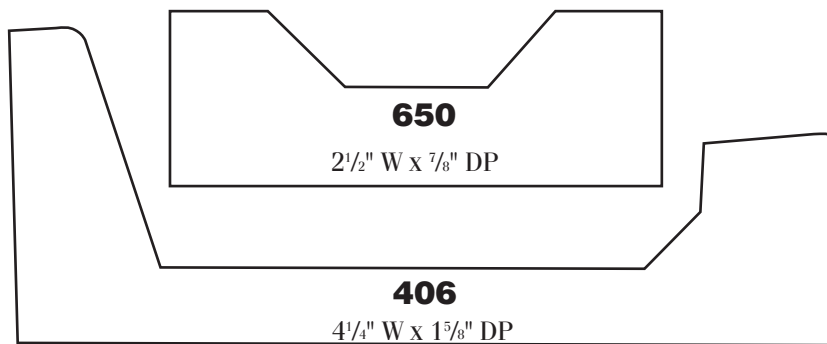

## MULLION

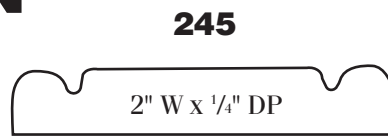
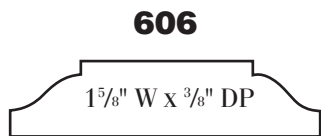

## NOSE & COVE

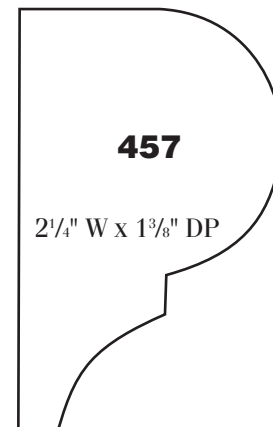
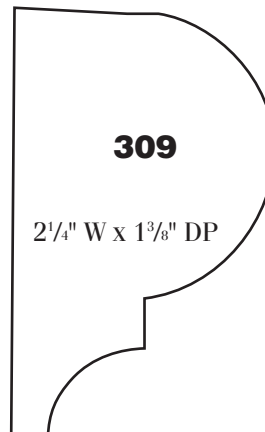
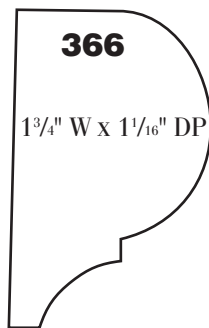
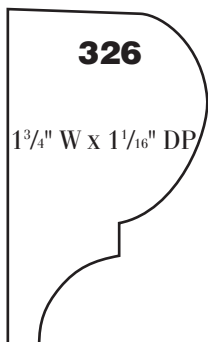
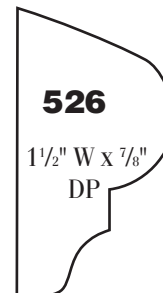
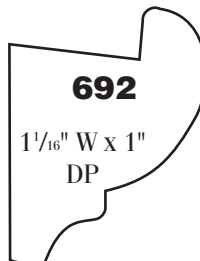

# FLEX MOULDING, INC.

## PANEL

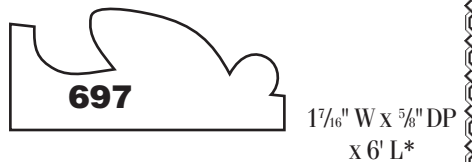
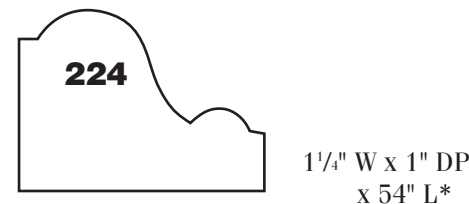
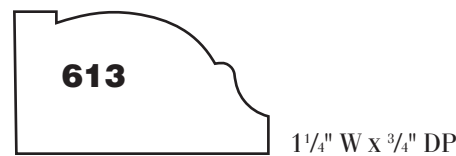
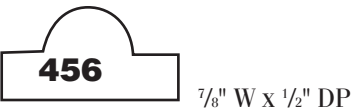
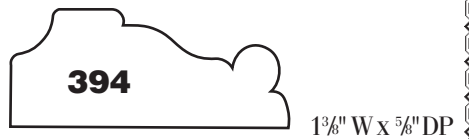
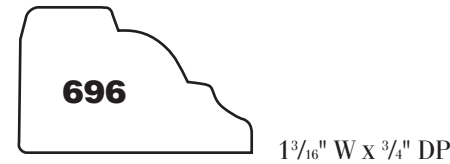
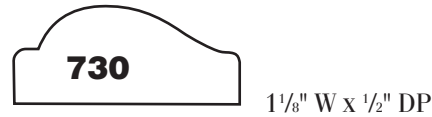
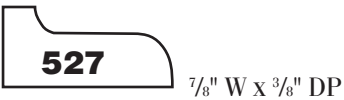
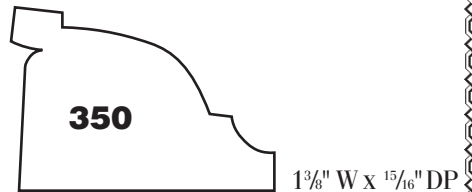
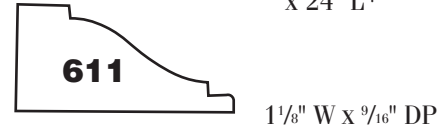
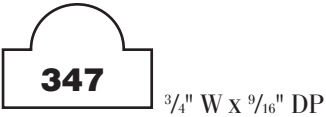
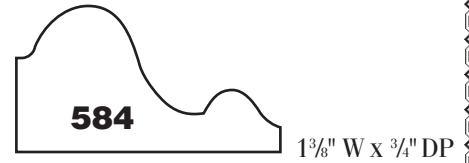
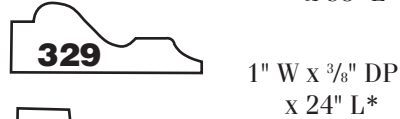
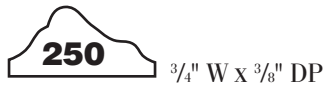
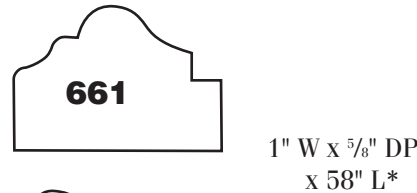
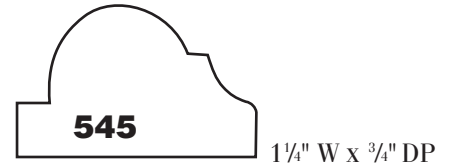
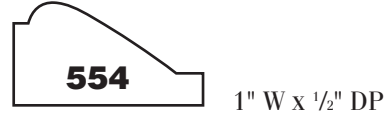
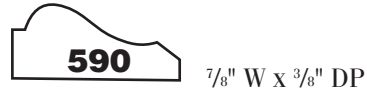
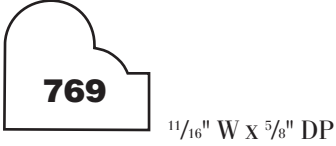
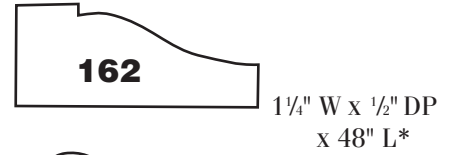

# FLEX MOULDING, INC.

## PANEL

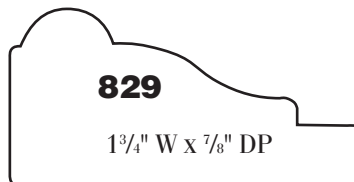
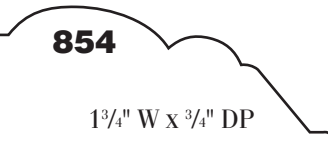
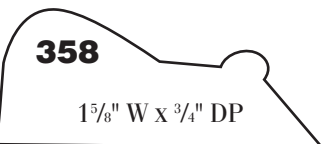
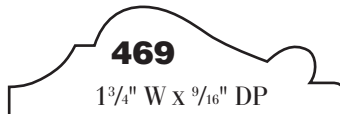
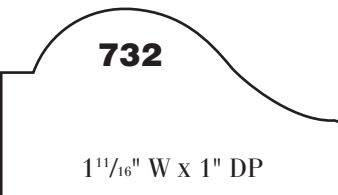
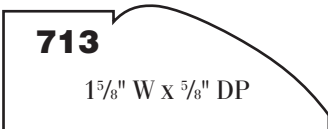
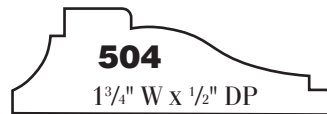
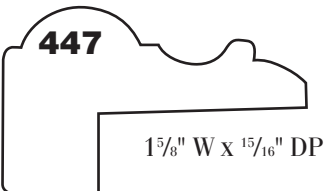
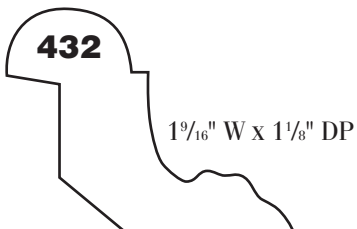
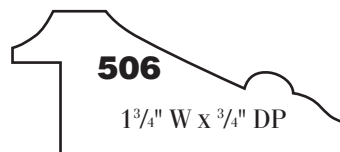
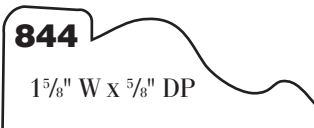
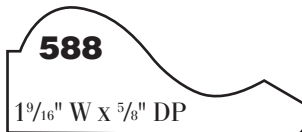
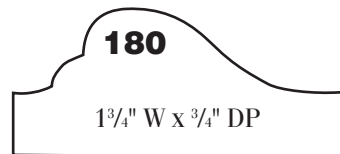
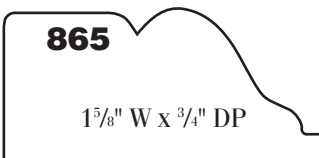
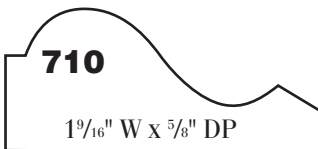
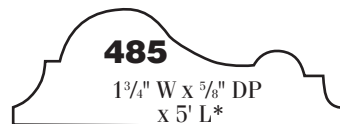
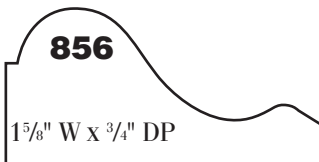
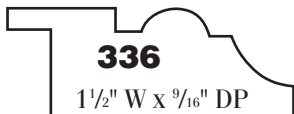
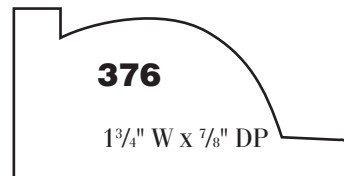
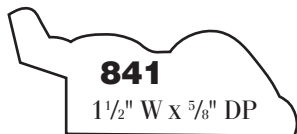
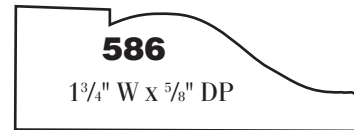
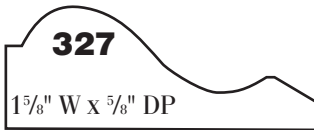
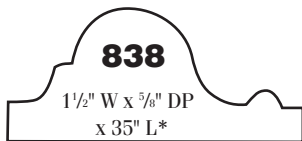
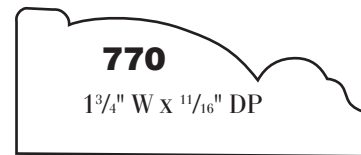
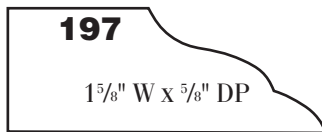
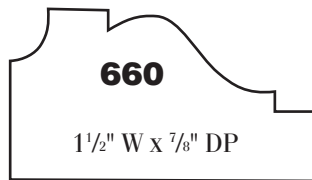

\*STANDARD IS 8' LENGTHS, EXCEPT WHERE NOTED

# FLEX MOULDING, INC.

## PANEL

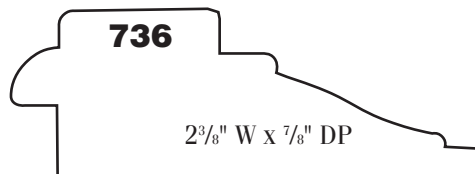
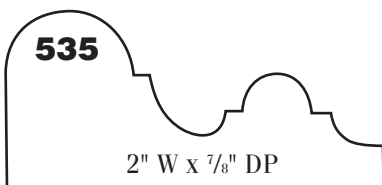
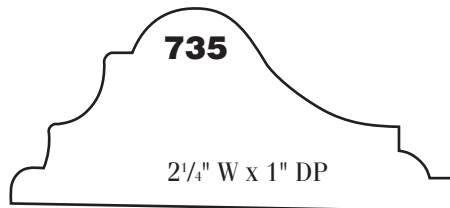
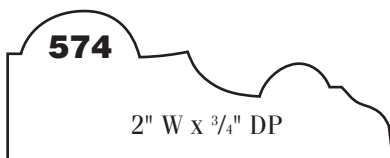
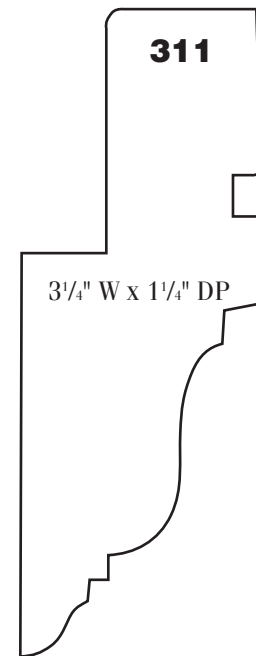
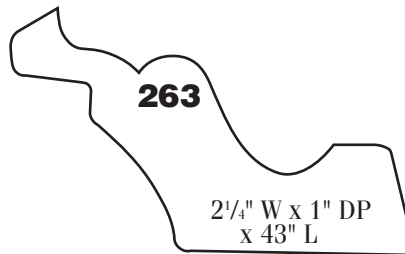
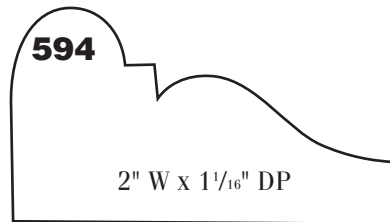
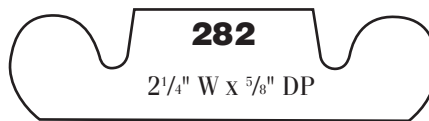
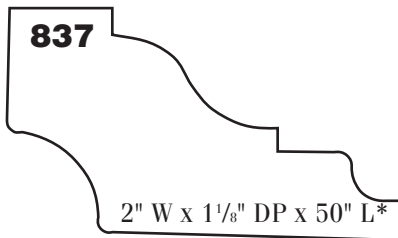
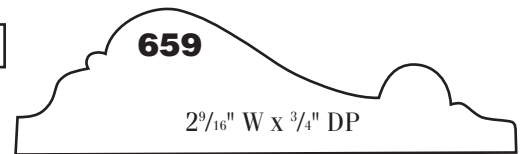
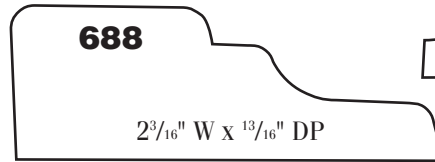
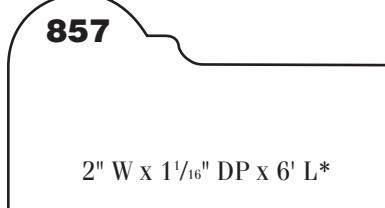
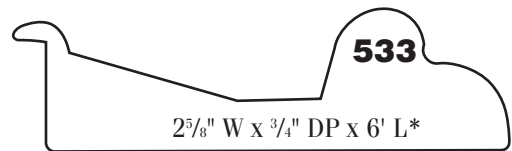
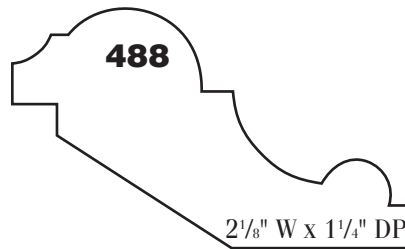
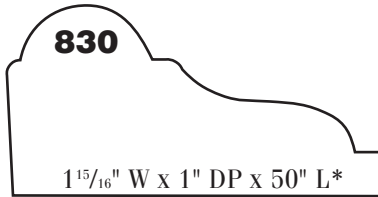
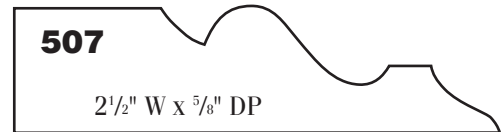
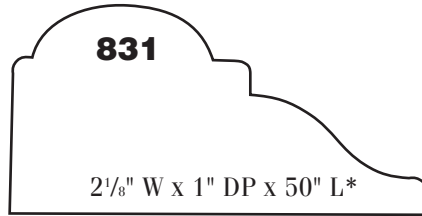
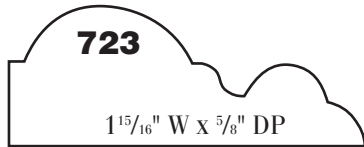
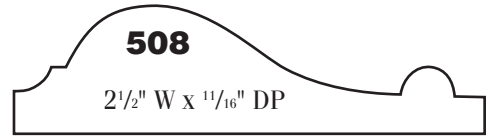
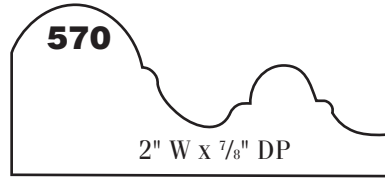
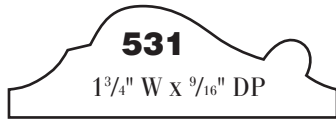

## PICTURE

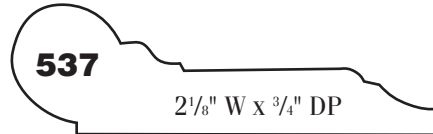
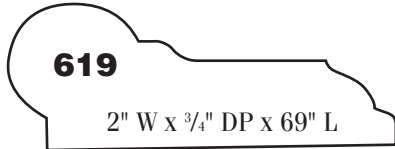
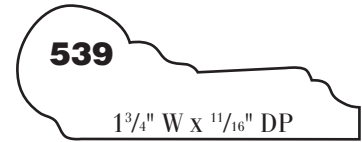
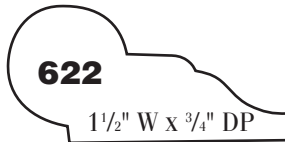
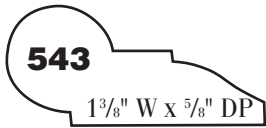

## PILASTER

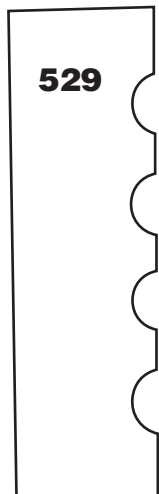

2 5/8" W X 3/4" DP

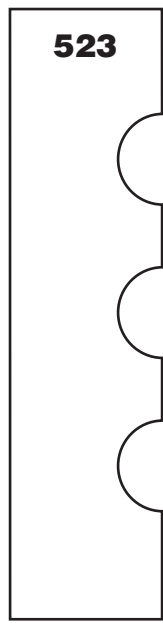

3 1/4" W X 3/4" DP

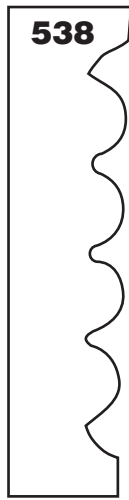

2 5/8" W X 3/4" DP



3 1/8" W X 3/4" DP



3 1/4" W X 3/4" DP

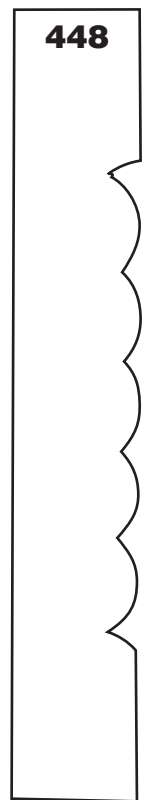

4 1/4" W X 3/4" DP

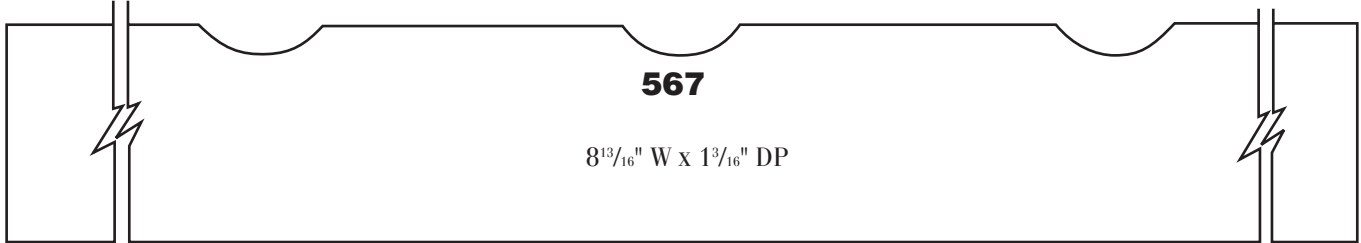

## SHELF EDGE

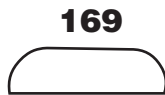

3/8" W X 1/4" DP X 36" L\*



3/4" W X 1/4" DP

## QUARTER ROUND

**519**



$\frac{1}{4}$ " W x  $\frac{1}{4}$ " DP

**750**



$\frac{3}{8}$ " W x  $\frac{3}{8}$ " DP



**156**

$\frac{1}{2}$ " W x  $\frac{1}{2}$ " DP

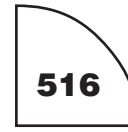

**516**

$\frac{5}{8}$ " W x  $\frac{5}{8}$ " DP

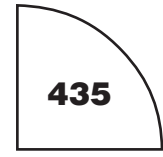

**435**

$\frac{3}{4}$ " W x  $\frac{3}{4}$ " DP

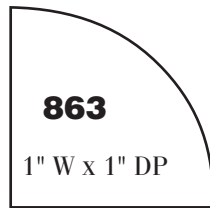

**863**

1" W x 1" DP

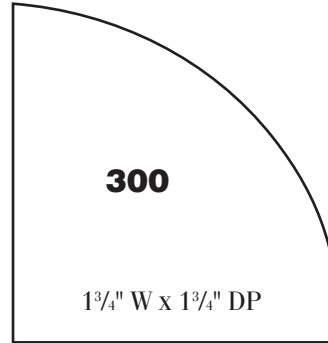

**300**

$1\frac{3}{4}$ " W x  $1\frac{3}{4}$ " DP

## SQUARE / RECTANGULAR STOCK

**271**

$\frac{1}{2}$ " W x  $\frac{3}{8}$ " DP

**862**

$1\frac{3}{8}$ " W x  $\frac{3}{8}$ " DP X 8' L

**239**

2" W x 1" DP x 60" L\*

**656**

$\frac{3}{4}$ " W x  $\frac{3}{4}$ " DP

**476**

$1\frac{1}{2}$ " W x  $1\frac{1}{2}$ " DP

**740**

$2\frac{1}{2}$ " W x  $\frac{3}{4}$ " DP

**345**

$\frac{7}{8}$ " W x  $\frac{3}{16}$ " DP

**275**

1" W x  $\frac{1}{2}$ " DP

**607**

$3\frac{1}{2}$ " W x  $\frac{1}{4}$ " DP

**706**

1" W x 1" DP

**443**

$3\frac{1}{2}$ " W x  $\frac{1}{2}$ " DP

**377**

$1\frac{3}{4}$ " W x 1" DP

**698**

$3\frac{1}{2}$ " W x  $\frac{3}{4}$ " DP

**758**

$1\frac{1}{8}$ " W x  $1\frac{1}{8}$ " DP  
x 48" L\*

**808**

$4\frac{9}{16}$ " W x  $\frac{3}{4}$ " DP

# SQUARE / RECTANGULAR STOCK

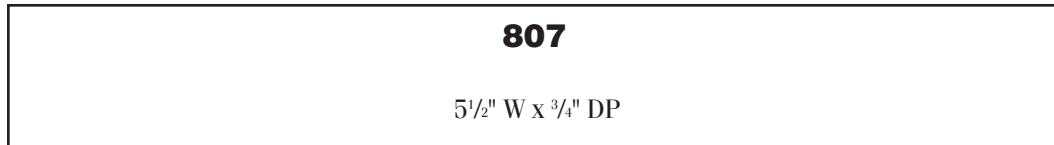
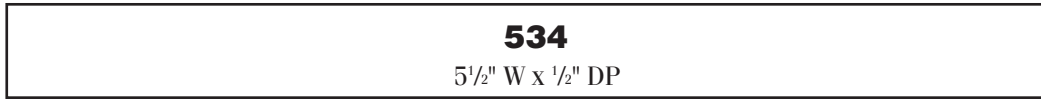

# SHOE



1 1/16" W x 7/16" DP



3/4" W x 1/2" DP



7/8" W x 3/8" DP



1 1/2" W x 1/2" DP

# STOOL

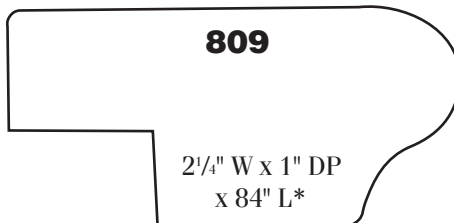

# STOP



3/4" W x 7/8" DP

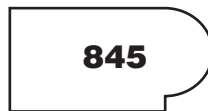

1" W x 1/2" DP



1 1/8" W x 5/8" DP

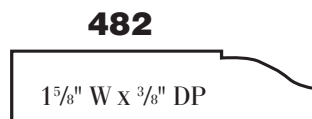
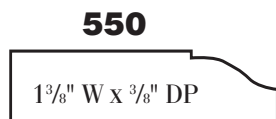

**FLEX MOULDING, INC.**

**16 EAST LAFAYETTE STREET**

**HACKENSACK, NJ 07601**

**(201) 487-8080 • 1 (800) 307-3357 • FAX: (201) 487-6637**

**WEBSITE: [www.flexiblemoulding.com](http://www.flexiblemoulding.com)**